

CUBICON Single Plus

User manual



INFORMATION TO THE USER

This equipment has been tested and found to comply with the limits for a Class A digital device, pursuant to Part 15 of the FCC rules. These limits are designed to provide reasonable protection against harmful interference when the equipment is operated in a commercial environment. This equipment generates, uses, and can radiate radio frequency energy and, if not installed and used in accordance with the instruction manual, may cause harmful interference to radio communications. Operation of this equipment in a residential area is likely to cause harmful interference, in which case you will be required to correct the interference at your own expense.

WARNING

Any changes or modifications not expressly approved by the manufacture could void the user's authority to operate the equipment.

This is the user manual (170118,En) of CIBICON Single Plus (3DP-310F). The user manual is subject to change without notice in purpose of the product function improvement. HyVISION System is not responsible for the user manual contained error or the user manual supply or use related loss. Images in the user manual are based on English.

Contents

1. Product introduction	5
2. Safety Caution	6
3. Directions for use	7
4. Product component and parts name	9
4-1. Product components	9
4-2. Product parts name	10
5. Installation and printing preparation	12
5-1. Unpacking	12
5-2. Filter installation	13
5-3. Filament installation	14
5-4. Printer power ON	15
6. Printer use	16
6-1. LCD control panel	16
6-2. LCD main screen	17
7. Filament replacement (Loading / Unloading)	18
7-1. Filament Loading	17
7-2. Filament Unloading	21
7-3. Filament replacement using 'Pause'	22
8. Test model printing	23
8-1. First printing	23
8-2. Printing with USB memory	23
9. Network	24
9-1.USB cable connection between PC and printer	25
9-2.WIFI connection	25
9-3. Cubicreator3 WIFI connection	29

10. User Interface	32
11. Printer maintenance and repair	44
11-1. Extruder detaching	44
11-2. Extruder maintenance	46
11-3. Auto leveling interface part maintenance	50
11-4. Heating bed maintenance	51
11-5. Filter replacement.....	52
11-6. Nozzle cleaning brush replacement period and method.....	52
11-7. Firmware update	53
11-8. Firmware recover	55
12. Trouble shooting.....	56
13. Product specification	60

1. Product introduction

Thank you for purchasing CUBICON Single Plus.

CUBICON Single Plus is one of the 3D printers of FFF type and easy to use and made in consideration of clients' convenience comparing to other general FFF type.

CUBICON Single Plus features include below.

- The printer case is made with flame resisting material and is relatively safe from fire. Stylish design of the printer came from exclusive painting.
- Detachable extruder replacement allows various material use. Therefore, filament of various material can be used.
- Gas and micro-dust are effectively removed using triple filter the first time in Korea.
- More advanced Auto Level of the printer is unveiled by taking over Auto Level Plus of CUBICON Single.
- Printout is possible and output takeout is easy without commonly used special adhesive taping work by Specially laminated bed
- Touch color LCD use along with immediate printing stop and pause is possible by 32Bit application
- Inside memory application allows outside memory separation after printing start. Therefore, private USB memory is not required anymore.
- One button is enough to check the printer problem by diagnosis function.
- 600 W high capacity power application allows safe printout and fast warm-up.
- The printer immediately enters into pause mode by filament detectable sensor application in the case of unwanted Filament decrement.

This user manual explains all process, from the printer installation to sample model printing step by step. Those users, who have already tried special technology of CUBICON 3D printer series, are also recommended to read this user manual carefully.

















Experience new 3D printing with CUBICON Single Plus

2. Safety caution

Please read and follow the guide of 'Safety Cautions' in prior to printer use.

Aim of the guide is to prevent printer user or third party injury and printer damage

Serious injury or printer damage may occur, unless you follow this safety guide.

	Risk of explosion if battery is replaced by an incorrect type. Dispose of used batteries according to the instructions.
	Fire may occur due to part of human body or any object input into printer as high heat occur during printer operation. Printer shall be stopped and cooled in the case of inputting human body part or any subject inside printer during printer operation.
	The printer operates movable parts such as motor, belt, gear etc. injury may occur due to getting jammed in movable parts in the case of putting human body or any subject into printer.
	User shall be cautious that fire or shock may occur in the case of putting water or other liquid or metal pieces or any other conductive foreign substances into the printer. Besides, do not handle the printer with wet hand as there is fire/electric shock danger.
	User shall be cautious on installation place as children or pet may get injured by the printer. Children or pet around the printer shall be under care and protection.
	Printer or its subsidiary materials include sharp surfaced parts. The user shall be cautious of any possible his/her body injury or printer damage.
	Do not heat or transshape main material of the printer-Filament, as it may cause fire or injury. User shall be cautious that suffocation may occur in the case of swallowing output or Filament leftover.
	Do not use volatile objects for the printer as it may cause fire/explosion. Remove any ignition or inflammable material from printer side, as negligence of such objects may cause fire.
	User shall protect his/her eyes from looking at the printer LED directly, as the LED contains high-brightness.
	Do not cause damage or transformation on the printer power and USB cable and do not supply power more than designated voltage power.
	In the case of moving printer, make sure to stop printer operation first and cool inside printer parts off, and then separate printer power and USB cable after turning off main power of the printer.
	Do not put Filament or other objects into empty space of the inside printer, as it may cause printer damage and fire.
	Do not turn off the printer power in heat condition of heating bed or extruder as it may cause printer malfunction or fire due to extreme heat by cooling fan malfunction.
	The printer uses materiall by melting them and may cause unique smell in the process of melting materials. Therefore the printer shall be installed in well ventilated place.
	Do not install the printer in places such as outdoor, direct sunlight reflective place, vibratory or humid place.
	Do not install the printer in wobble or uneven place. Remove any objects from around the printer, which may cause printer damage due to heat or vibration in the printer operation process.
	The compnay do not guarantee the printer damage or quality in the case of not using the company supplied Filament or components. All problems, which are caused by such cases are excluded from complimentary A/S.
	User shall not dismantle or remodel the printer arbitrarily apart from the printer instrucion manual allowed parts. Problems, injury or printer damage, which are caused by such cases are excluded from complimentary A/S.
	Do not cause extreme impact or shock to the printer as it may cause damage or injury. Users are advised to use the printer after reading precautions section of the instrution manual.

3. Directions for use

Please read and follow the guide of 'Product use precautions' in prior to printer use.

Filament	<p>User shall use the manufacturer's original filament.</p> <p>* Printer malfunction caused by imitation filament use excluded from complimentary A/S.</p>
	<p>Unpacked filament shall be used as soon as possible.</p> <p>In the case of keeping, filament shall be kept in sealed condition after fastening it to a spool to prevent filament unpacking.</p>
Filament spool Installation and separation	<p>Filament shall be installed considering rotation direction and a door handle locking condition shall be inspected after installation.</p>
	<p>Filament shall be prevented from coming loose from spool in the process of separating filament spool from the printer.</p>
Filament replacement, loading unloading	<p>User shall be cautious of extruder temperature setting.</p> <p>* Extruder malfunction may occur in the case of wrong temperature setting due to nozzle blockage, filament dividing etc.</p>
	<p>User shall be cautious of temperature setting and shall remove filament of inside nozzle.in the process of new filament replacement.</p>
Temperature condition of heating bed and nozzle	<p>Nozzle/heating bed shall be heated and used with appropriate temperature for the filament in use.</p> <p>* Printing quality faulty and equipment malfunction, such as filament carbonization, extruding faulty, dividing, and floor bird-caging may occur in the case of out of scale of filament in use temperature.</p>
	<p>Once printing is finished, a model shall be separated after cooling heating bed off.</p>
Detachable extruder and nozzle cleaning	<p>Regular extruding condition inspection and cleaning control are required.</p> <p>* Worn nozzle replacement caused by regular use is excluded from complimentary A/S.</p>
	<p>Outside of nozzle shall be cleaned with pure cotton cloth after heating nozzle.</p>
	<p>User shall be cautious of damage of inside extruder in the process of inside nozzle cleaning with the nozzle control pin.</p> <p>* User shall get proficient to prevent extruder malfunction due to wrong use.</p>
	<p>The nozzle control pin shall be used after detachable extruder separation to prevent inside extruder damage.</p> <p>The nozzle cooling, heating repetition is prohibited in the condition of putting filament inside nozzle.</p>
Detachable extruder Separation/ combination	<p>Make sure to turn off the printer power before separation/combination.</p>
	<p>The printer power shall not be turned off in the heat condition of detachable extruder. (The printer power can be turned off in the case of detachable extruder separation right after turning off the power for repair/replacement etc.)</p>
Fixed extruder	<p>Regular cleaning control of fixed extruder is required.</p>
	<p>Contaminants of visible gear of fixed extruder bottom side and contaminants of filament channel shall be removed after detachable extruder separation.</p>

Heating bed cleaning	<p>General cleaning is conducted by cleaning surface contaminants with scraper, dry cotton cloth.</p> <p>* Damaged lamination of heating bed, caused by regular use, is excluded from complimentary A/S.</p> <hr/> <p>Cleaning shall be conducted with only high-purity acetone in the case of serious contamination.</p> <p>* Do not use general cleanser (wet tissue) for cleaning as it may contain substances, which may cause bed lamination damage.</p>
Auto tilt	<p>Nozzle touch process in section of level contact point shall be inspected in the case of error occurrence of auto tilt process. And heating bed contact point and cleaning the end of nozzle (steel brush is recommended for cleaning). Inspection/repair by A/S center is required in the case of continuous error.</p>
Preparation of AS requirement	<p>In the case of any problem occurrence, user shall take a photo or video of problematic file and problem situation, inside printer, LCD display etc. for inspection/repair.</p>

4. Product component and parts name

4-1. Product components name

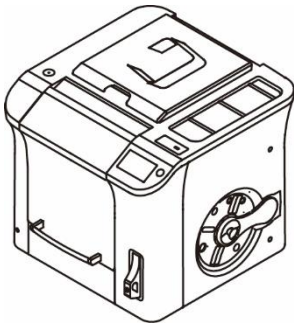

Cubicon single plus

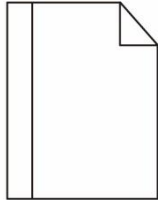

Quick Guide

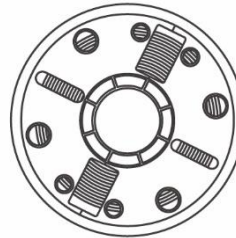

Filament

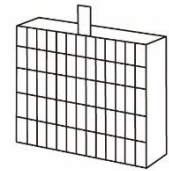

Filter

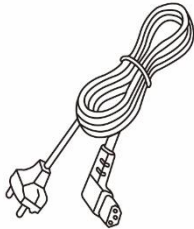

Power cable

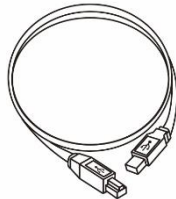

USB cable

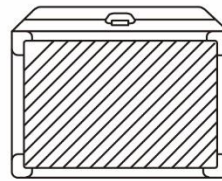

Tool box

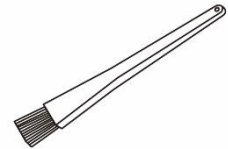

Antistatic brush



Scraper

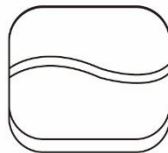

Bed cleaning brush



Tweezers



Control pin

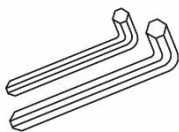

Wrench 2 type (2Ø, 2.5Ø)



USB memory

* The product included secondary accessory type and spec are subject to change without notification for the product function improvement

* User can purchase additional subsidiary accessories through homepage or designated distributor.

* Subsidiary accessory is excluded from A/S as it is service product.

* Material and color of first filament supply are provided randomly.

* Manual, cubcreator are included in USB memory. Updated version can be downloaded at homepage

(www.3dcubicon.com)



4-2. Product parts name

(1) Cubicon single plus body

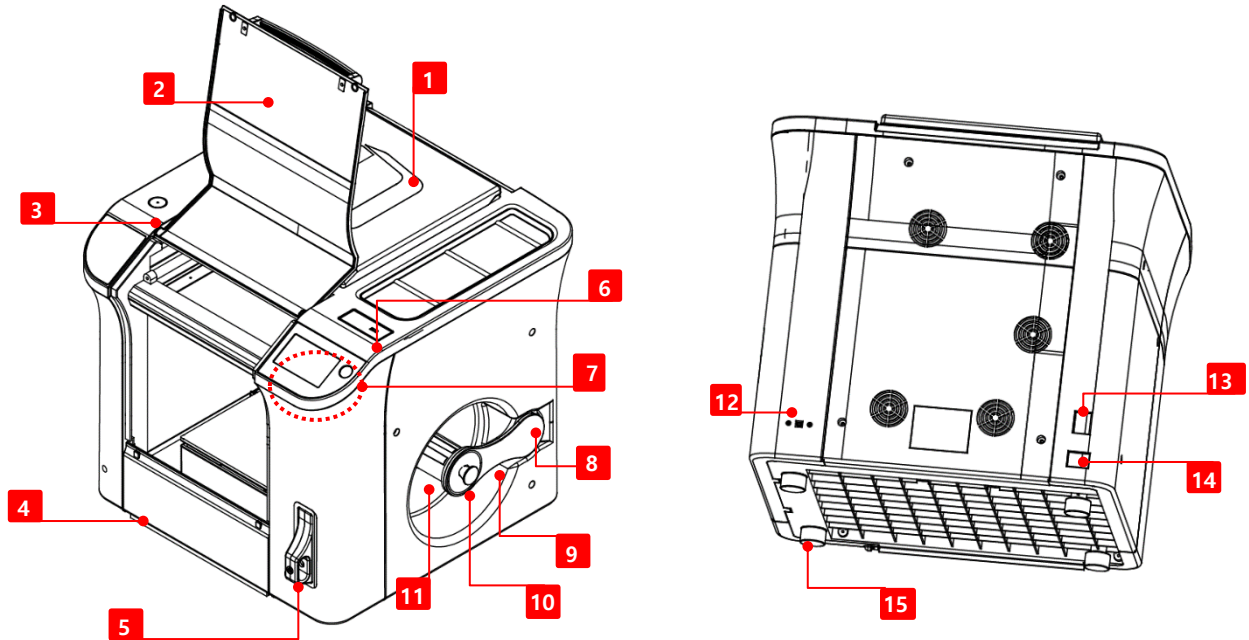

[1] Top door	Is used for filament replacement, detachable extruder separation and maintenance/repair.
[2] Front door	Is used to pull out the model part
[3] Level	Is used for horizontality inspection in the printer installation process
[4] Bottom door	Is used for floor cleaning
[5] Clean filter case	Is input to clean filter.
[6] USB memory insert hole	Is inserted to USB memory.
[7] Touch LCD and Reset	Is used for urgent stop of touch LCD and printer.
[8] Filament insert hole	Is used to supply filament.
[9] Spool door	Is used for filament spool fixation
[10] Spool door handle	Is used to lock the spool door (make sure to lock the door after spool installation)
[11] Spool carrier	Is filament spool installation place
[12] USB input	Is the input socket (Type-B) for PC and USB connective cable
[13] Power switch	Is the main power switch of the printer
[14] Power input	Is the connective socket of printer power.
[15] Rubber feet	Is used to prevent the printer sliding(four spot on a floor)

(2) Cubicon single plus extruder

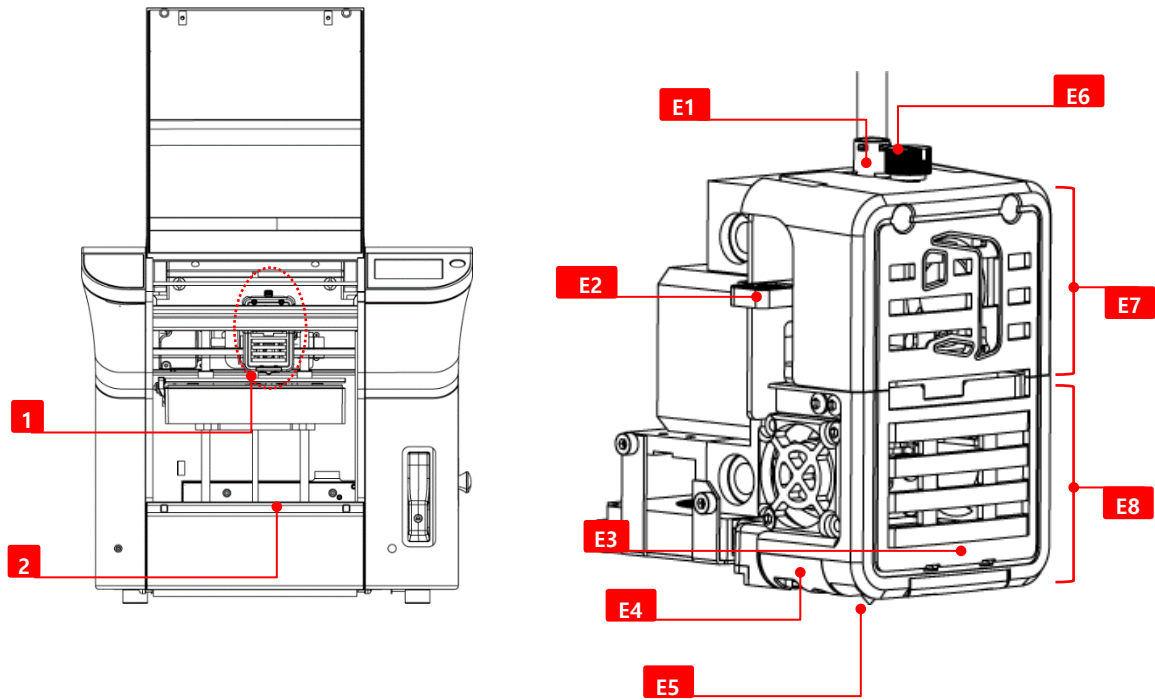

[1] Extruder part	Spills filament and melts it and sends to nozzle
[2] Heating bed	Is printing platform of output in the printing process.
[E1] Filament insert hole	Is the hole which puts filament into extruder. A Teflon tube is placed inside it.
[E2] Filament press handle	Is the handle, which manually takes out filament from inside extruder and is pressed in the inserting process
[E3] Formative LED	Is the white LED to check the model status, and is located in detachable extruder part.
[E4] Wind guide	Is the tool, which blows modeling fan wind to a model side and is located in detachable extruder part.
[E5] Nozzle	Melts and comes out from filament.
[E6] Removable setscrew	Is used for detachable extruder part separation.
[E7] Fixture extruder part	Is fixture part of extruder.
[E8] Detachable extruder part	Is removable part of extruder.

5. Installation and printing preparation

5-1. Unpacking

<p>① Take out the product from plastic packing.</p>	<p>② Move the product to installation spot.</p>
	
<p> * Considering volume and weight of the printer, at least two persons shall handle the printer. * Release the printer from plastic packing and then take out only the printer without plastic packing as plastic material may slip in the process of taking out.</p>	
<p>③ Open the front door and take out inside packing material, accessories and check out if any material is missing.</p>	<p>④ Open the top door and take out extruder fixture packing material. Make sure not to break the extruder driving cable or a Teflon.</p>
	
<p> * The driving part is fixed only with packing material without using cable tie to prevent potential problems when the printer is operating with it. Please, be careful not to damage the part when removing the internal packing material.</p>	

* Driving cable of the extruder or a teflon tube is placed near extruder fixture packing material.
 Make sure to prevent from pull, breaking, stabbing, press etc. as the extruder connective cable and the Teflon tube are supply channel for the extruder operation and the filament.

5-2. Filter installation

① Pull out a filter from the printer body.

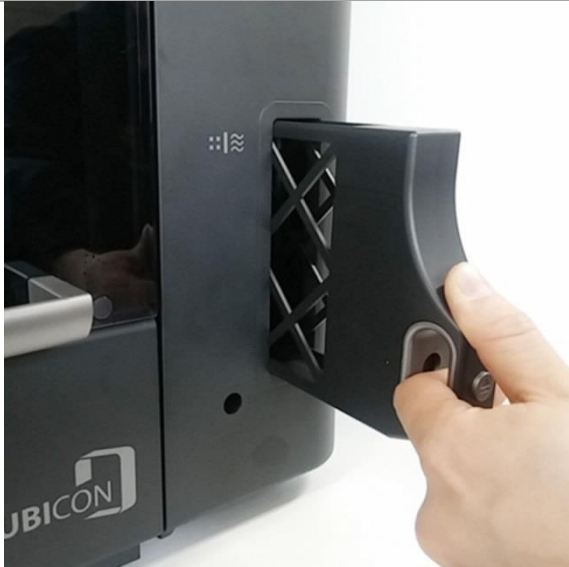

② Put the filter into a case considering their direction.

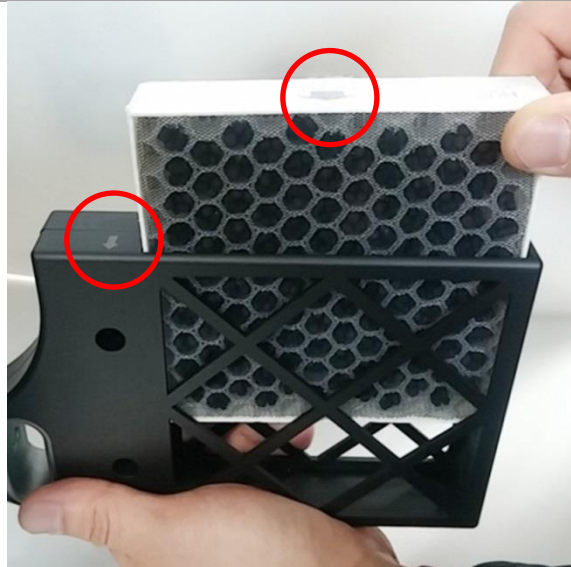

③ Insert clean filter case into the printer body.



* Make sure to insert the clean filter into the printer body in normal direction.
 * In the case of wrong inserting direction, the filter function decreases and it may cause a ventilation fan malfunction.

5-3. Filament installation

① You can open by pushing back a spool door handle of the printer body.



② Slowly release the filament from filament spool and push the filament into filament insert hole * be careful of the rotation direction

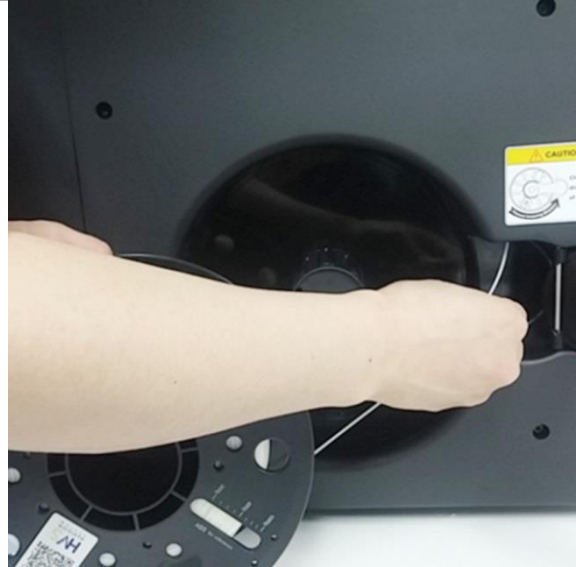

③ Open the top door and push in the filament until it comes out of Teflon tube entrance



④ Insert the filament spool into filament bar and fix spool by closing the spool door pressing handle until you hear clicker.



* Filament spool has its own direction (Install the spool, make sure that company logo or the product sticker side is visible from outside)

* Any interruption between filament bar and the spool, in the process of the filament spool installation, may cause the printer malfunction as it raise the problem in a filament supply. Make sure to remove an obstacle, which causes interruption to rotation in the spool insert process. Make sure to remove a spool package included silica gel from inside spool.



* A teflon tube is the channel from the filament spool to the extruder. if the tube is pulled with extreme power, tube breaking, or tube twisting may occur and it may cause abnormal filament operation and malfunction as the teflon tube length is optimised to the printer. Do not break, cut or pull installed teflon tube with extreme power.

	<p>* Make sure that the filament does not come loose in the process of taking out remaining filament spool. And fix the remaining filament to the spool. Make sure that remaining filament does not come loose in storage process.</p> <p>* Keep remaining filament in use in a plastic bag to prevent it from outside exposure such as humidity and dust. Make sure to use filament as soon as you open it. If the filament is exposed to external environment for a while, the printing quality may get worse, it stops extruding from the extruder.</p>
--	--

5-4. Printer power ON

	<p>Make sure to recheck inside packing material removal, any part damage, the spool installation condition/rotation direction/rotation condition etc. in prior to turn on the printer power.</p>
	<p>Do not neglect the printer by turning off the printer power in heat condition of the extruder. The printer malfunction may be caused due to electronic part damage by abnormal cooling fan operation.</p>
<p>① Change power switch (O) of the printer body to 【OFF】</p>	<p>② Put a power cable to a socket.</p>
<p>③ Change the power switch () of the printer body to 【ON】</p>	<p>④ Check the indication of LCD screen.</p>



* In the case of power or USB cable separation, make sure to separate it by pulling connector and do not hold the cable.

6. Printer use

6-1. LCD control panel

Urgent stop

Press Reset (Emergency) button so that the printer stops its operation immediately and proceed rebooting (soft booting) in the case of problem occurrence in the printer operation.

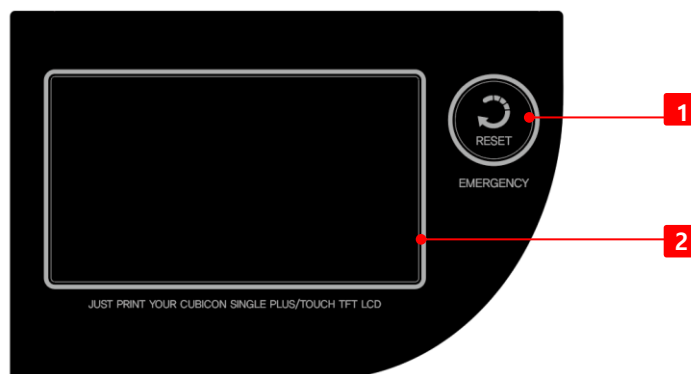

[1] Reset

Press Reset (Emergency) button, then the printer will reset immediately.

[2] Touch LCD

'Touch LCD' shows current condition screen or menu on a touch screen.



Make sure not to press Reset button accidentally in printing process or do not put any object near Reset button as it may cause the printer reset pressing Reset button.

6-2. LCD main screen

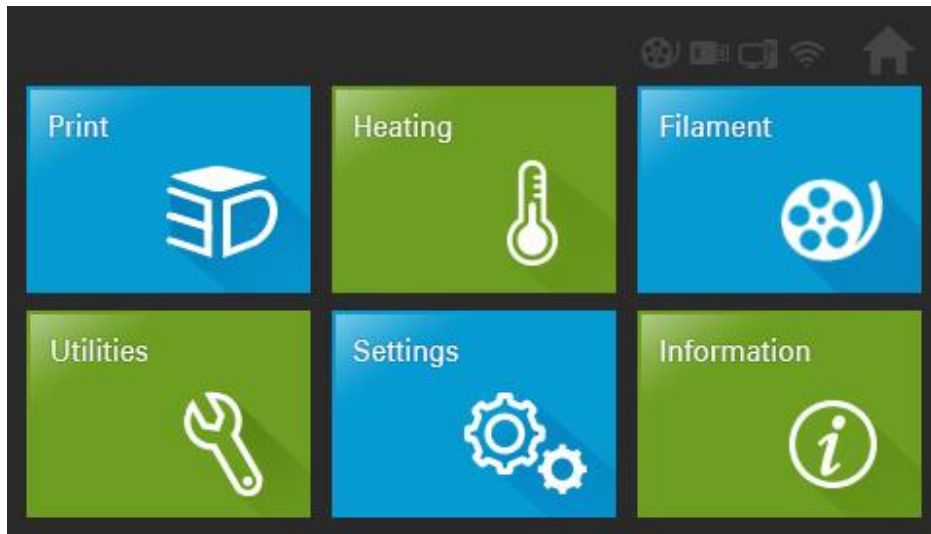

[1] Print	'Print' menu is used for printing the saved file of inside the printer or the saved file of USB memory.
[2] Heating	'Heating' menu is used for warm-up by nozzle/bed material.
[3] Filament	'Filament' menu is used for the filament loading/unloading.
[4] Utilities	'Utilities' menu is used for G-code copy/delete and the extruder movement, self-diagnosis, auto level etc.
[5] Setting	'Setting' menu is used for amendment and firmware update matching to CUBICON Single Plus
[6] Information	'Information' menu indicates the printer information and time, inside memory capacity.

7. Filament replacement (Loading/unloading)

Filament-printing material shall be inserted into the extruder for filament melting with a nozzle and for pushing it. The extruder inserted filament shall be removed to replace another filament.

Loading means process of inserting filament into the extruder by melting with nozzle and pushing it, in an empty extruder condition to print a material out. On the other hand, unloading means the process of taking out filament from extruder.

7-1. Loading



Select 'filament' from main menu.

Press 'loading' button, once you select the filament to load.

Select 'start' button, once temperature reach the target temperature.

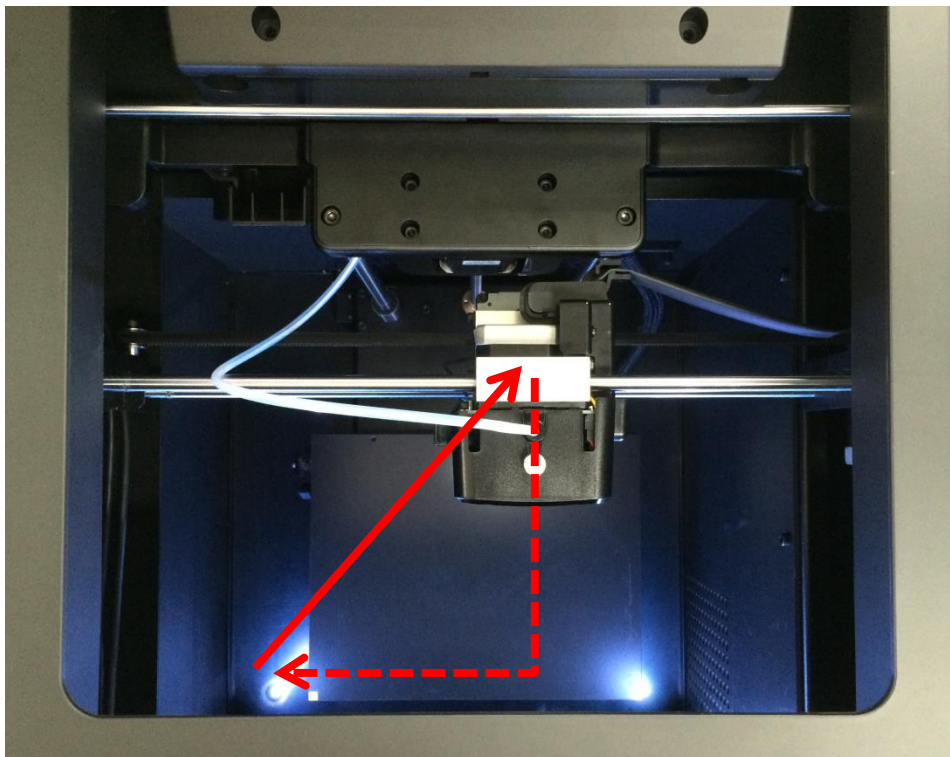

Be cautious of safety as the extruder moves toward parking location.

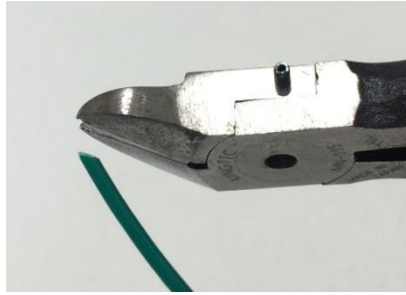

Cut the end part of filament carefully with a knife or scissors.

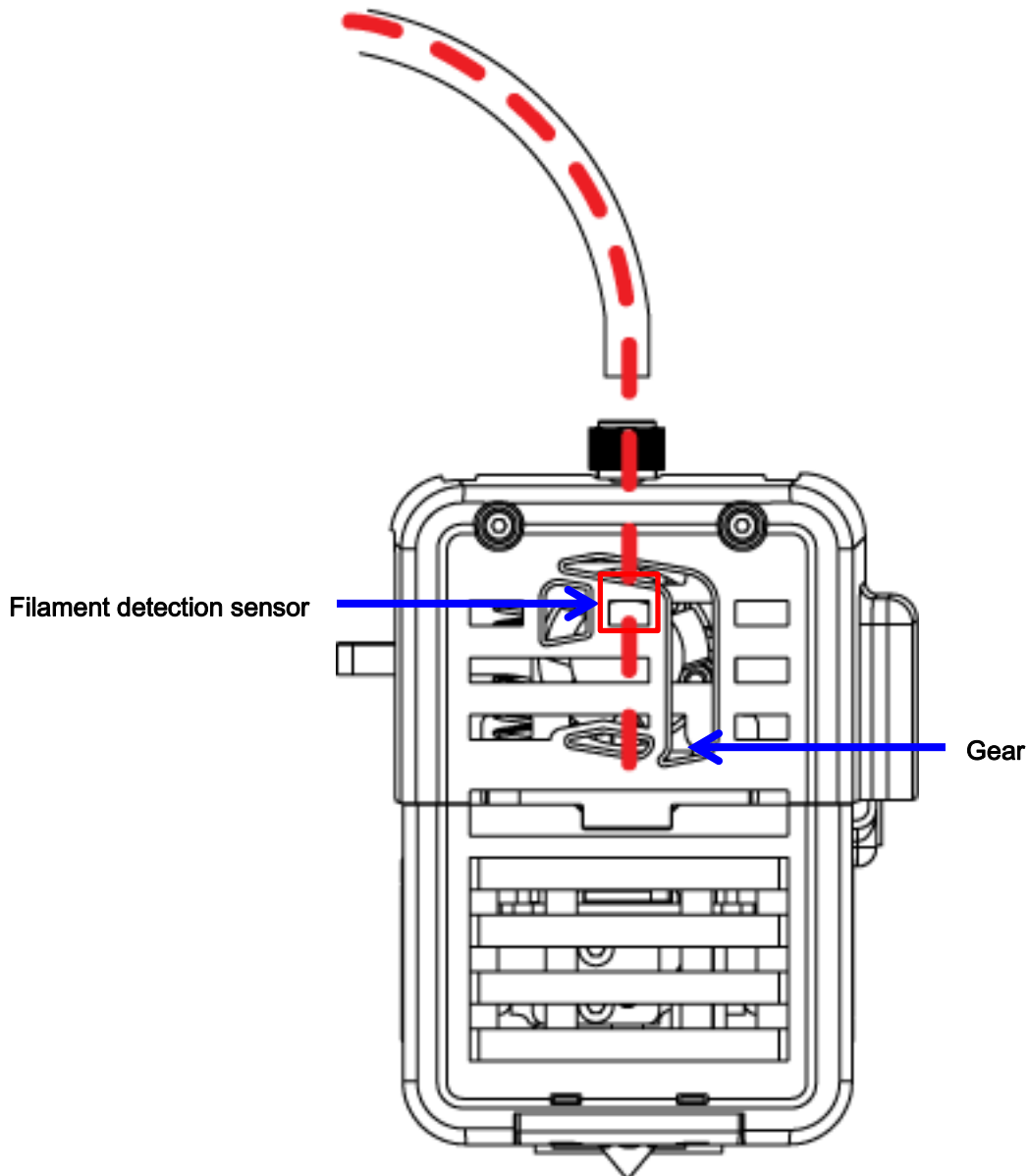

Push in the filament until gear entrance passing through the filament detection sensor.

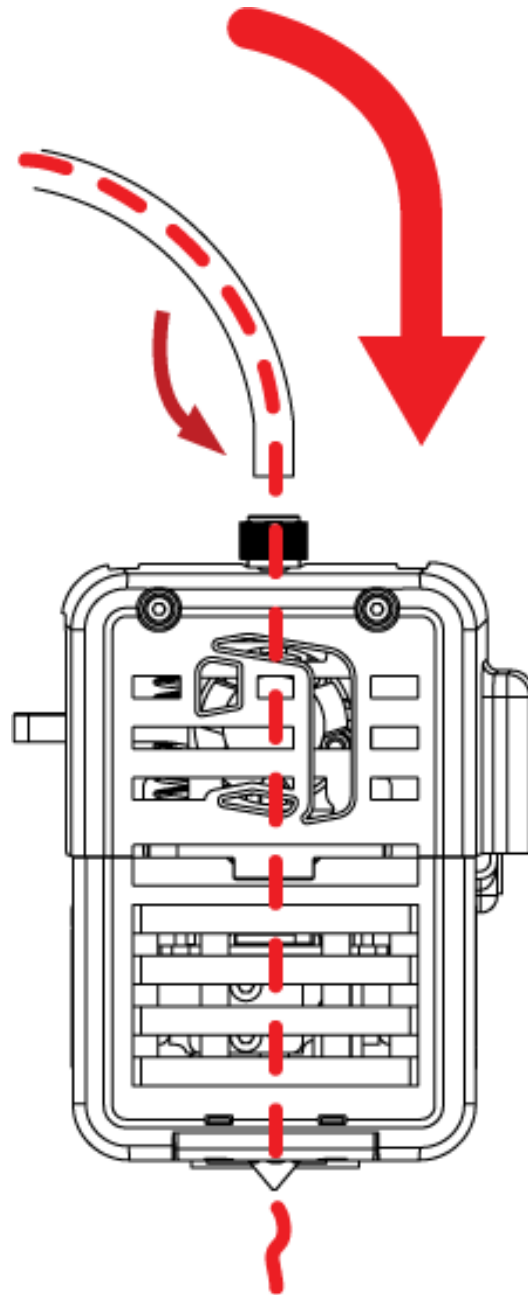

Make sure to check if the filament is extruding through a nozzle.



- * Make sure to keep a nozzle part away from your body as nozzle gets hot once nozzle temperature of the extruder gets high and melted filament is also hot.
- * The filament may get caught to a nozzle bar entrance in the process of the filament goes into nozzle bar of detachable extruder part. (you may hear crack sound) In that case, press the filament press handle and pull filament up. Then cut the end part of filament with scissors and try loading again putting the filament into insert hole.
- * In the case of manual working by using the filament press handle, make sure not to pull the filament up with extreme power as it may cause inside sensor or nozzle bar damage.

7-2. Unloading



Select 'Filament' from the main menu.

Press 'Unloading' button, once you select 'Filament' to unload.

Press 'Start' button, once temperature reach target temperature.



Press handle and take out the filament, once you see an icon on LCD screen, which indicates the filament takeout pressing handle.

	<ul style="list-style-type: none"> * Do not touch nozzle part as not only nozzle but melting filament, once the nozzle temperature of the extruder goes up. * Make sure to take out the filament by pressing handle. * Make sure to prevent possible malfunction as melted filament end part may get caught inside extruder.
	<p>*The filament might get caught inside the extruder in unloading process as filaments' end part are different from each other by their type. Do not pull out the filament forcefully with your hand, in the case of possible caught in or difficulty of the filament pull out.</p> <ol style="list-style-type: none"> 1) unloading by pushing the filament into the nozzle and correcting it through melting the filament end piece or 2) Separate detachable extruder and remove the filament after cutting out the filament of outside extruder. Forcible filament pull out may cause the filament (leftover) caught in of inside the extruder and it may lead to fixed extruder part repair.

7-3. Filament replacement using 'Pause'.

The filament replacement can be conducted easily to use by 'Pause' function of Cubicon Single Plus. User can replace the filament in advance, if the remaining filament is not enough. User can also change color by replacing different colored filament.

(1) 'Pause' by user.

Printing is stopped and the extruder moves to parking point, once 'Pause' button is pressed. Then installed filament can be replaced or other work can also be conducted.

Pressing 'Continue' button allows restarting printing, once required work is completed.

(2) Pausing due to filament run out.

There is a filament detection sensor of Cubicon Single Plus.

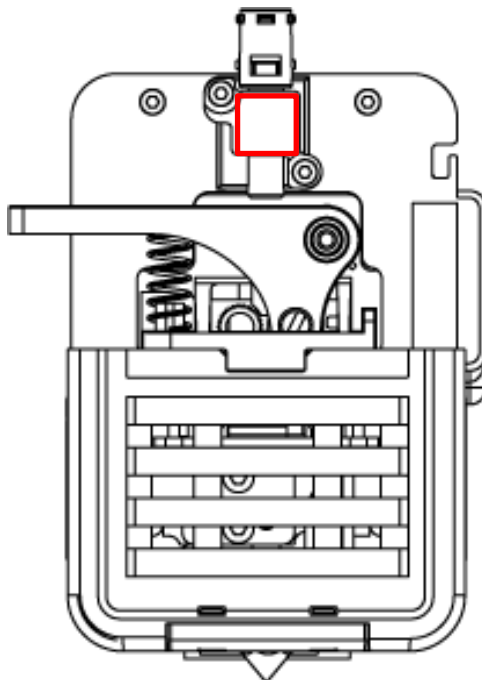

The printer automatically goes in 'Pause' mode, once sensor, as shown above picture, indicates filament run out.



- * Sensor may not operate properly due to TPU ductility ,in the time of TPU printing. Make sure to go to Setting > Function > Filament check OFF in prior to using ductile filament.
- * Filament pieces, which come out by automatic unloading in the time of the filament passes through the detection sensor, might be different depending on the printer model. **The amount of filament pieces might decrease as far as area gets wider and it makes pull out of filament pieces impossible.** Make sure to check remaining filament amount in prior to printing, as reprinting might be needed.

8. Test model printing

This section explains from the installation to printing by using USB memory. Refer to Cubicreator Software manual for method of printing through PC and USB cable connection.

8-1. First printing

① '7-1 Start loading after reading 'Loading' section.

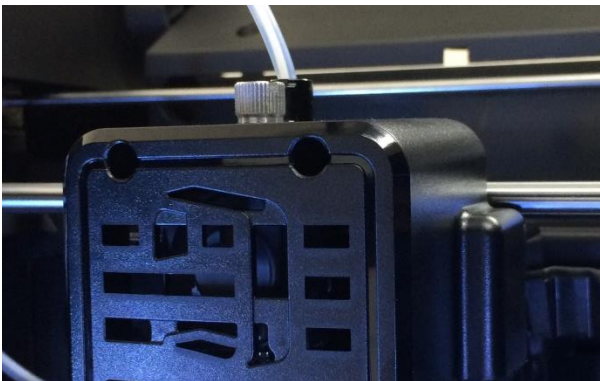

② Loading completion means printing preparation completion.

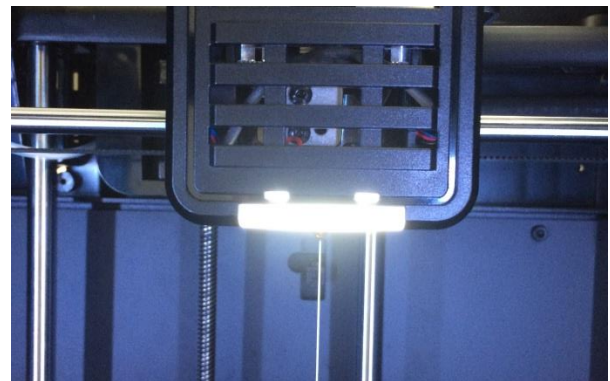

8-2. Sample file of USB memory printing

Direct printing

① There is a sample file for printing in provided USB memory.

② Select a file icon by pressing a print icon. Select installed filament suitable clip.hfb file and print it out.

Saving and printing

① Select 'Utilities' button and go to 'File manager'. Select USB memory and select clip.hfb file and copy it.

② Press the printer icon again and select file icon. Select copied clip.hfb file, which is suitable to installed filament and print it out.



* In the case of direct printing method, copy is made to inside memory but unlike saving and printing method, once you print next file, previous file will be deleted automatically. Make sure to save the file and print it out, if you want to save the file to inside memory.

9. Network

In order to print with Cubicon single Plus, make sure to save sliced file to USB memory and insert the printer USB to slot and print the saved file or printing can be conducted by connecting PC and USB cable or WIFI. This section explains about USB cable connection and WIFI connection. (In order to print through a network, over Cubicreator v3.1* version shall be used.) Once printing starts in Network connection printing process, (after slicing data transmission to the printer is completed.) normal printing can be processed, even if Network breaks.



* WPA2PSK security setting for a router is recommended. Other security level are not guaranteed.
 * Connection error may occur in the case of SSID includes korean letter, special characters, chinese characters etc.
 * WIFI connection shall be directed to router installation spot antenna. Connection property may be different, depending on a router.
 * Printing shall be proceeded after transmitting slicing data form PC in order to print through WIFI connection. Transmission failure may occur in the case of unstable connection. USB memory use is recommended if the slicing data is big.

9-1. USB cable connection between PC and printer

PC and the printer are connected with USB cable. (Make sure to install a cubicreator related driver in the cubicreator installation process.)

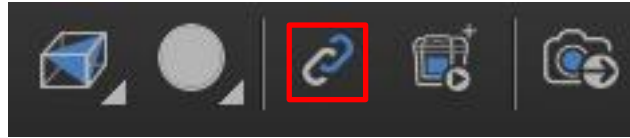

Indicated icon activation means completion of printing preparation. Refer to the cubicreator manual for detailed printing method.

9-2. WIFI connection

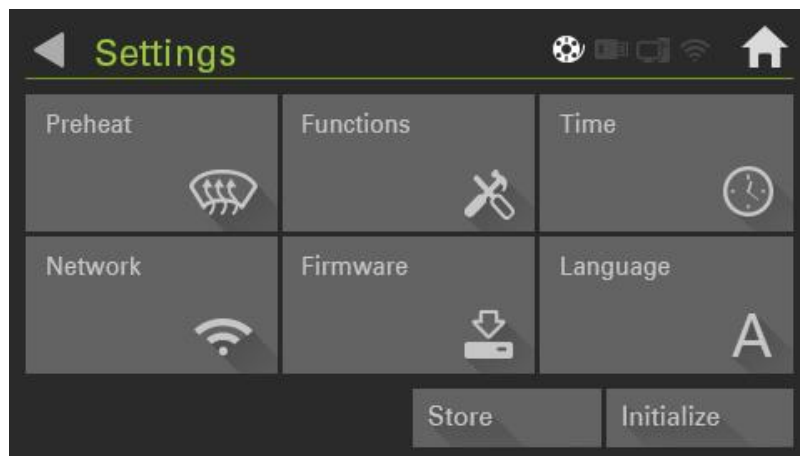

Go to 'Settings' and select 'Network'.

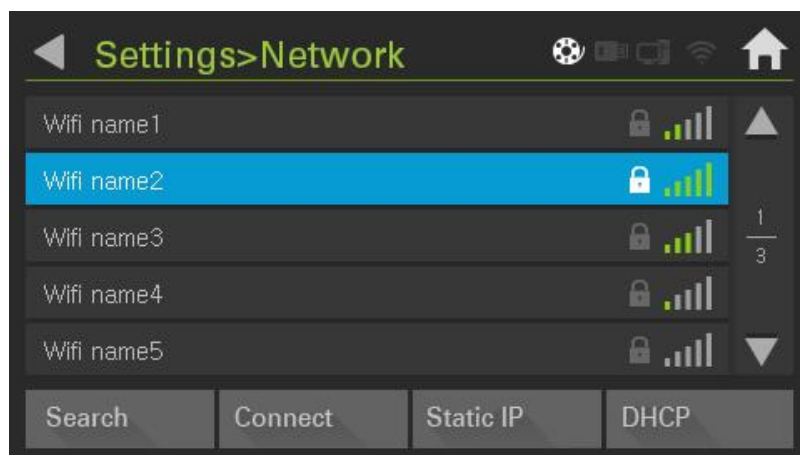

Select one between Static IP and DHCP, press search, and search for available WIFI. Once you find available WIFI, select it.

(1) DHCP connection

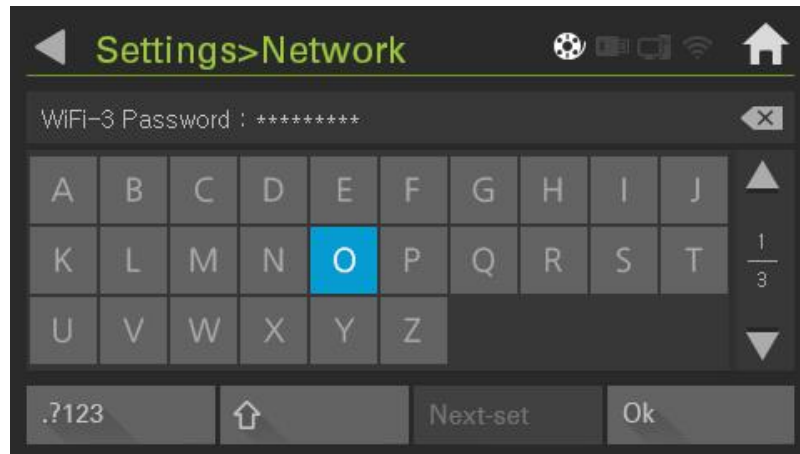

Press 'OK' and start connection, once you finish inputting password.

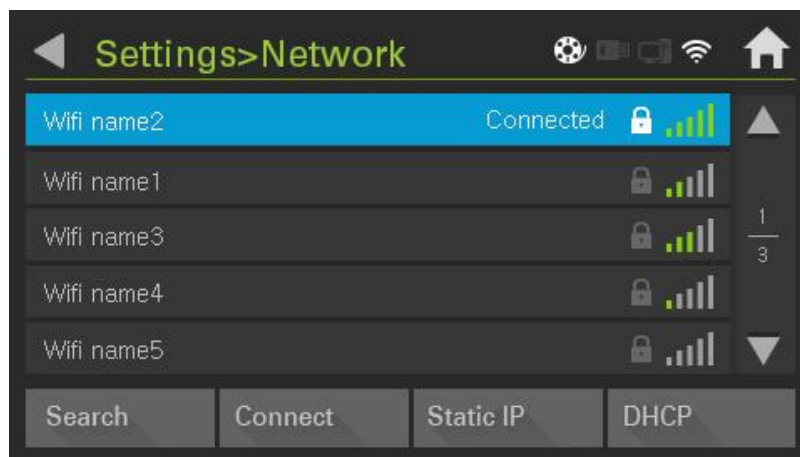

'Connected' indication will activate, once connection is completed and Network Setting of Cubicon single plus is completed.

(2) Static IP connection

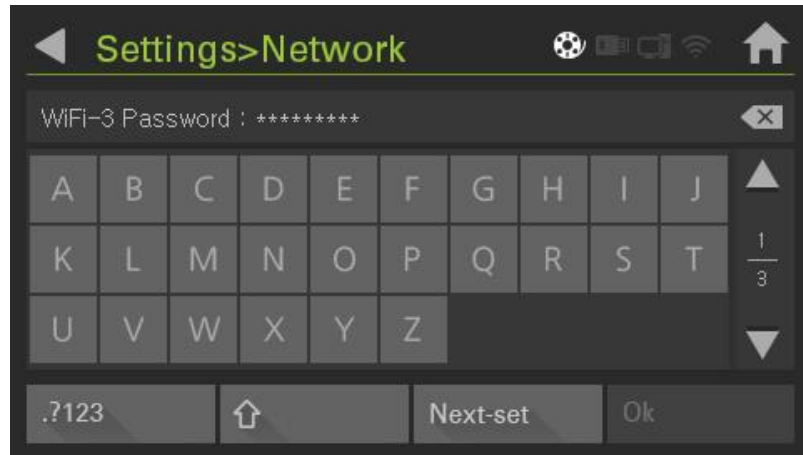

Input password and select 'Next-set'.

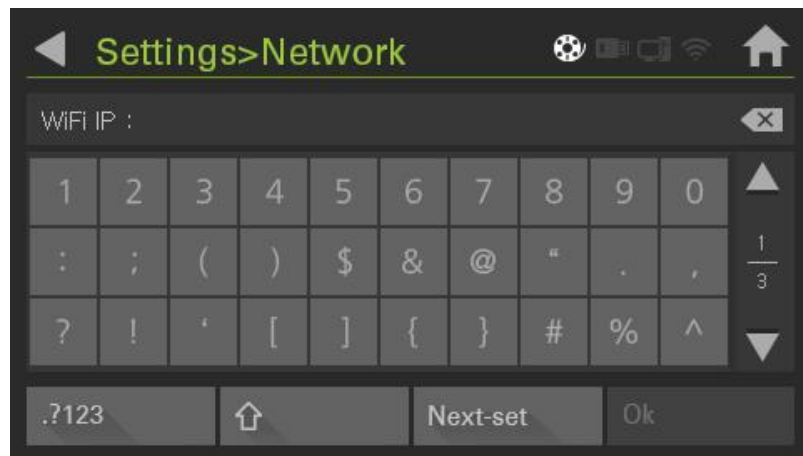

Input WIFI IP.

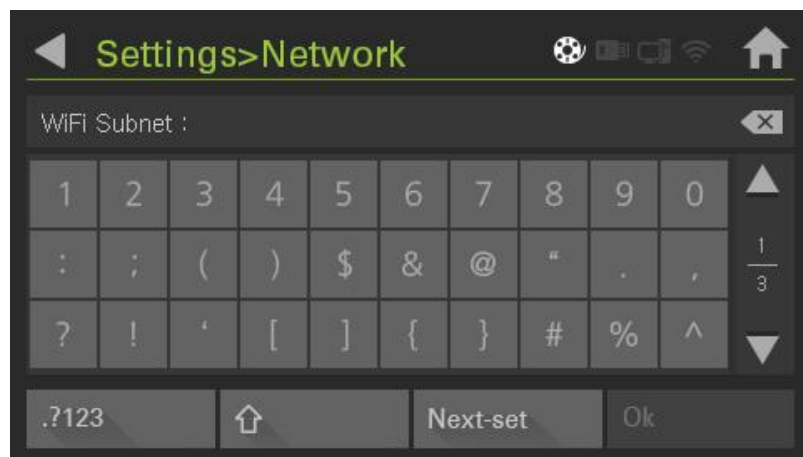

Input Subnet

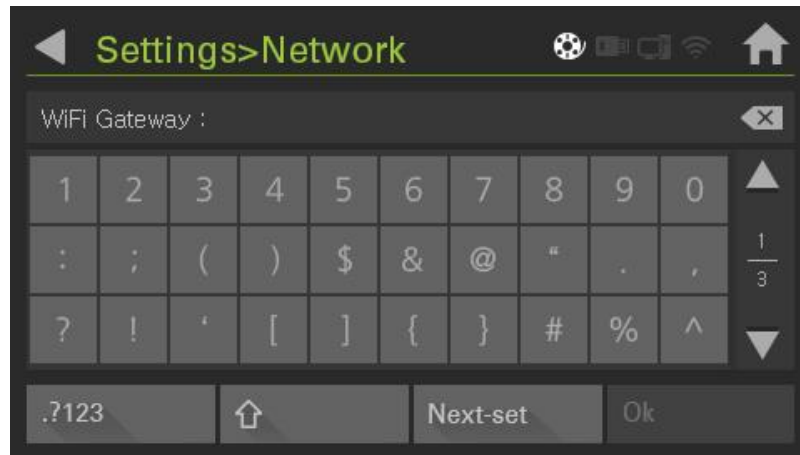

Input Gateway, press 'OK' and start connection

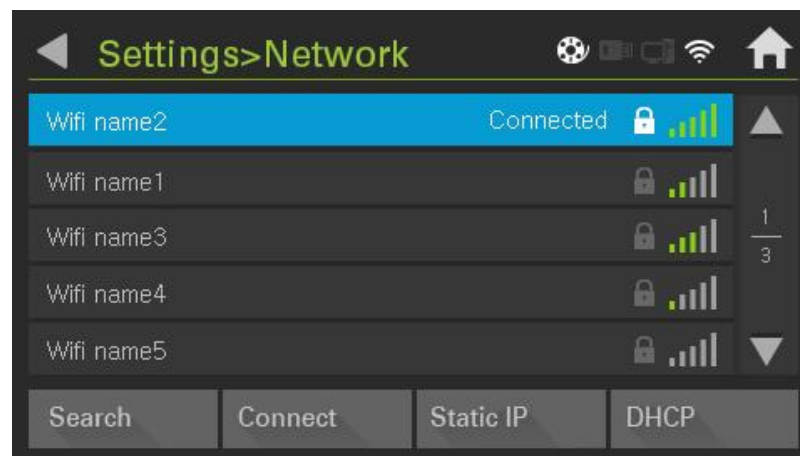

'Connected' indication will activate, once connection is completed and Network Setting of Cubicon single plus is completed.

(3) Connected IP check

User can check current printer IP on 2/2 screen by pressing 'System information' on the main menu after WIFI connection.

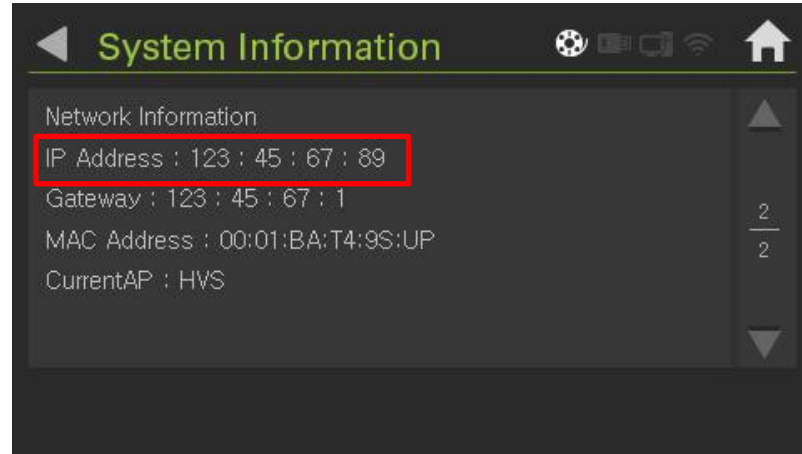

9-3. Cubicreator3 WIFI connection

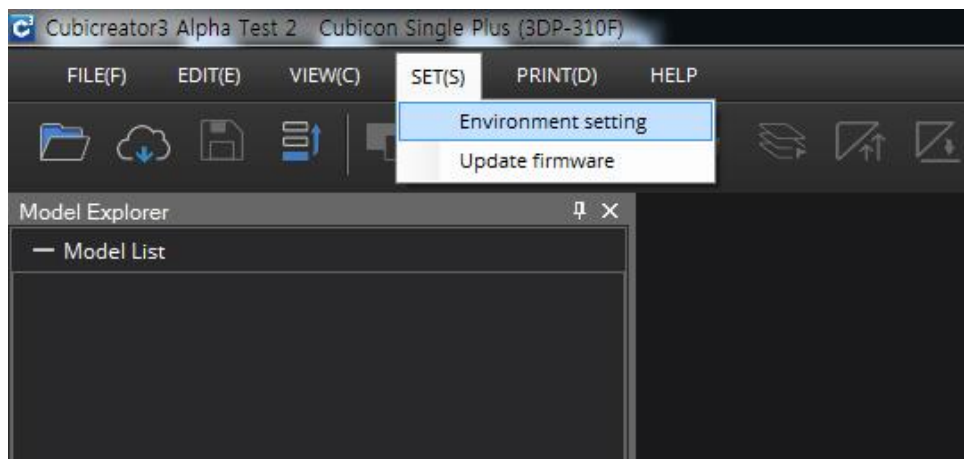

Activate Cubicreator 3 and select 'Environment setting'.

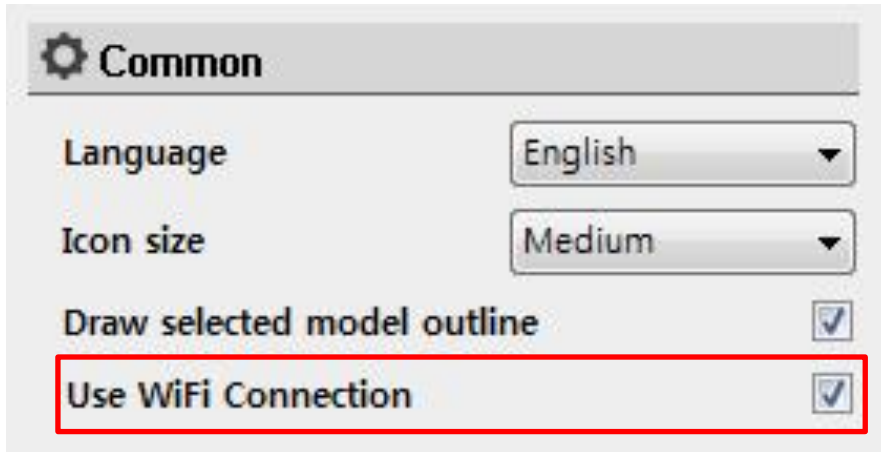

Select 'Use WiFi Connection' option.

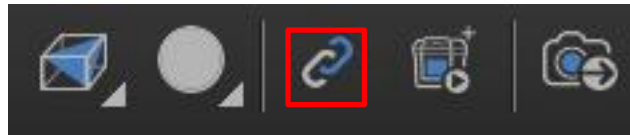

Press connection icon. Connect with related printer IP. Refer to Cubicreator3 manual for details.

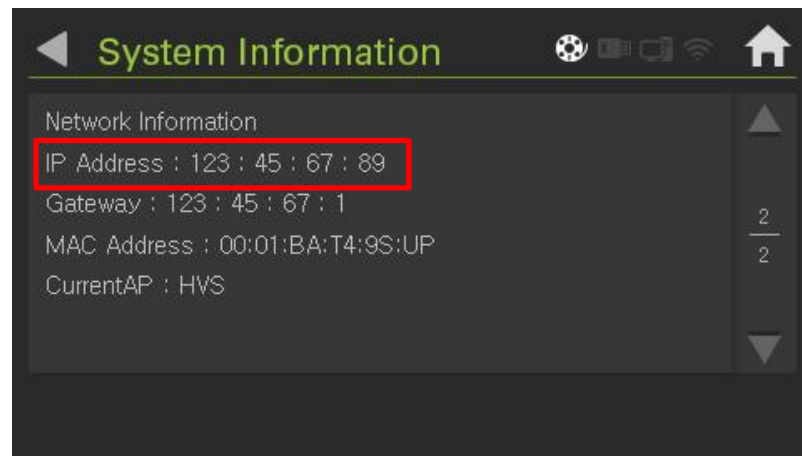

IP can be checked on 2/2 of 'System Information'.

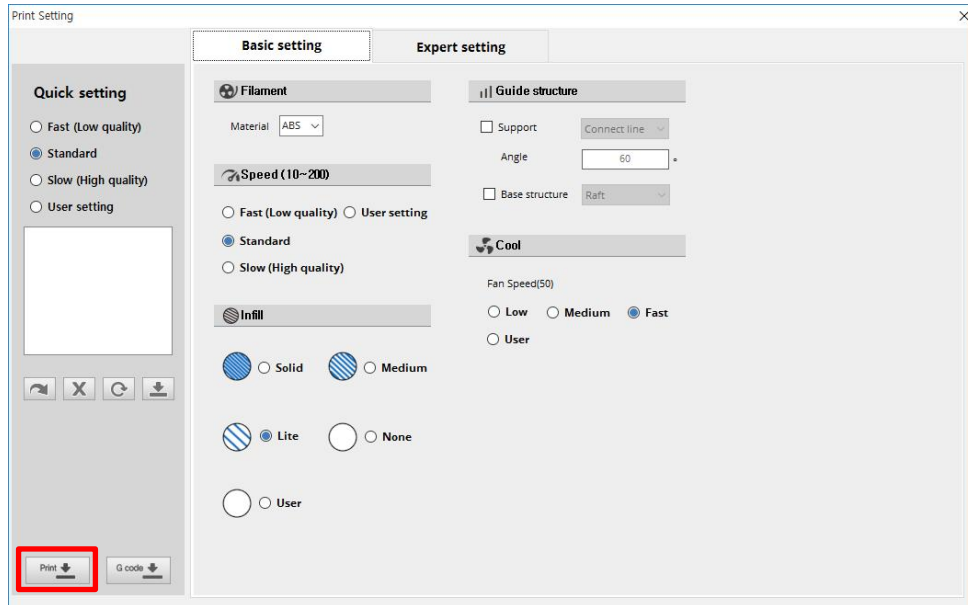

Once proper connection is finished, Print icon will activate in the same way with USB cable connection.

10. User Interface

Menu tree

Print		Heating		Filament		
•Print standby status		Cool Down		Start		
Start(Deactivated)		ABS		Stop		
File	- Start	PLA		Unloading		
	- Up-Folder	TPU		Loading		
	- Information	USER				
	- USB / I - Memory					
Heating						
Filament						
• Printing under process						
Pause						
Stop						
Heating						
Filament						
Utility		Setting		Information		
File Manager	- Copy	Preheat				
	- Delete	Function				
	- Up-Folder			- Filament Check		
	- USB / I - Memory			- File Sorting		
	- Filter Fan					
Motion	- Extruder		- Rear Fan			
	- Bed		- Tilt Offset			
	- Motor	Time				
	- D-Gear		- Search			
Diagnostics	- Start	Network				
LED& Sound	- Store			- Connect		
	- Initialize			- Static IP		
				- DHCP		
Auto Level Test	- Filament	Firmware				
	- Start	- Download				
System Log	- Copy	Language				



* Menu composition of pre-print and printing under process are different.
 *. Menu composition is subject to change in accordance with a firmware and cubicreator version.

• Main > Print > Ready for Print

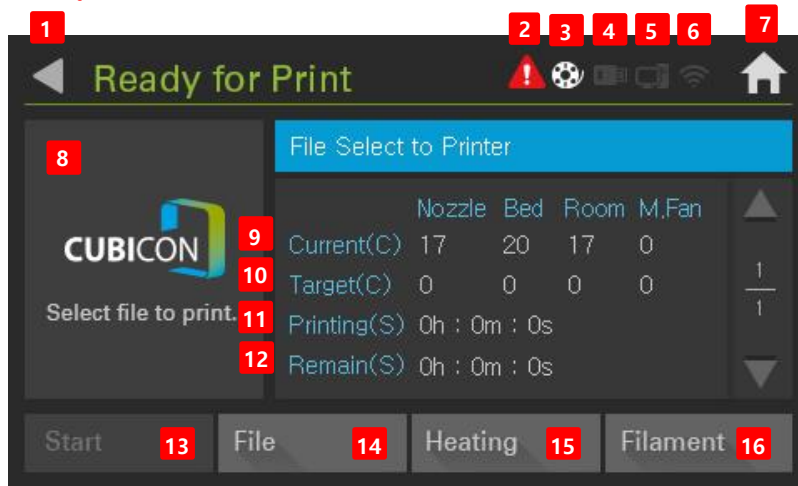

[1] Back	Goes back to previous screen
[2] Error	Notifies the printer problem. (if 'Error' is pressed on main screen, it enters to 'Diagnostic')
[3] Filament	Is the icon indicating the filament presence
[4] USB Memory	Is the icon, which indicates USB memory activation
[5] PC	Is the icon, which activates in the time of connection with PC
[6] Wi-Fi	Is the icon, which activates in the time of WIFI connection
[7] Home	Goes back to the main screen
[8] Image	Indicates printing file image and is activated in the time of Gcode formation with Cubicreator 3
[9] Current	Indicates current temperature
[10] Target	Indicates fixed temperature of Gcode
[11] Printing	Indicates process time of printing model
[12] Remain	Indicates remaining time of printing model
[13] Start	Is in deactivation mode in the first start
[14] File	Selects file to print out
[15] Heating	Enters to Heating menu
[16] Filament	Enters to Filament menu

•Main > Print > file Selection

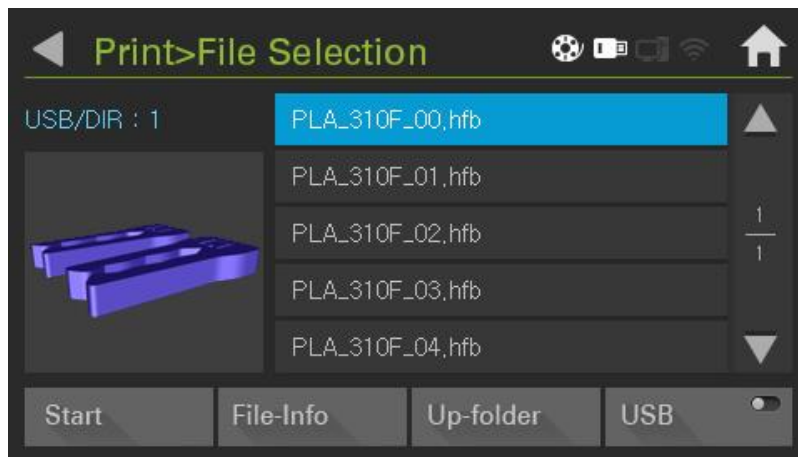

[1] Start	Prints selected file
[2] File-Info	Shows information of selected file (over Cubicreator3.0 version)
[3] Heating	Enters to Heating menu
[4] Filament	Enters to Filament menu

• Main > Printing...



[1] Pause	Pauses printing
[2] Stop	Stops printing
[3] Heating	Controls current temperature

• Main > Printing Pause



[1] Continue	Connects and prints paused files from paused point.
[2] Stop	Stops printing (Pup-up is activated after FW1.1)
[3] Heating	Controls current temperature
[4] Filament	Enters the filament loading / unloading

• Main > Heating

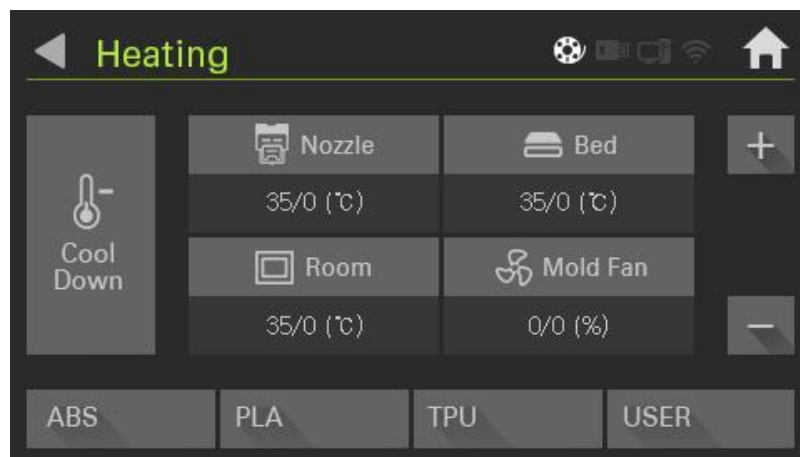

[1] Nozzle	Nozzle temperature
[2] Bed	Bed temperature
[3] Room	Inside printer temperature
[4] Fan	Controls shaped fan wind power
[5] +	Increase selected number
[6] -	Decrease selected number
[7] Cool Down	Initializes all temperature setting value
[8] ABS	Warms up basic setting temperature of ABS
[9] PLA	Warms up basic setting temperature of PLA
[10] TPU	Warms up basic setting temperature of TPU
[11] USER	Warms up user setting temperature. Basic temperature is 0°C

• Main> Filament

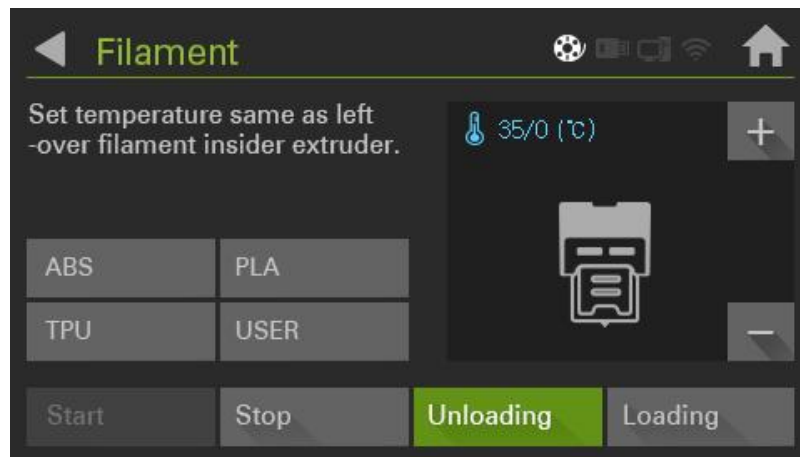

[1] Filament type	Selects filament.(ABS, PLA, TPU, user description)
[2] Start	Starts selected operation
[2] Stop	Stops current operation
[3] Unloading	Pulls out filament
[4] Loading	Puts in Filament

• Main > Utilities

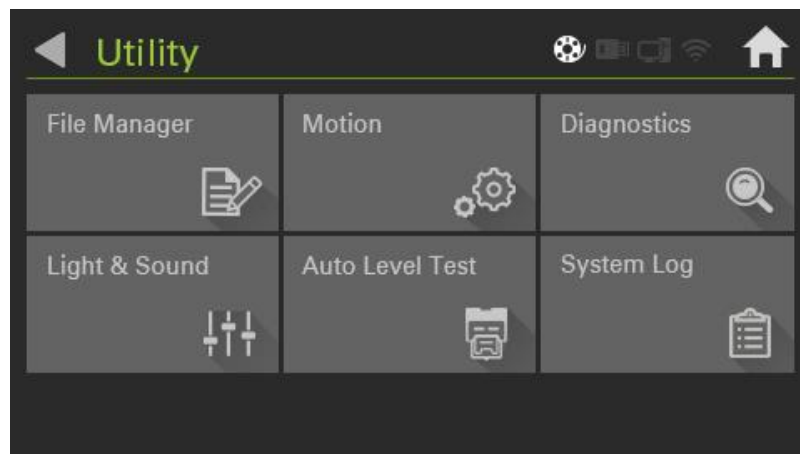

[1] File Manager	Copies and deletes USB / inside memory file
[2] Motion	Starts selected operation
[3] Diagnostic	Decides malfunction presence with self-diagnosis
[4] LED & Sound	Adjusts LED color selection and volume
[5] Auto Level Test	Measures bed flatness
[6] System Log	Copies saved log

• Main > Utilities > File Manager

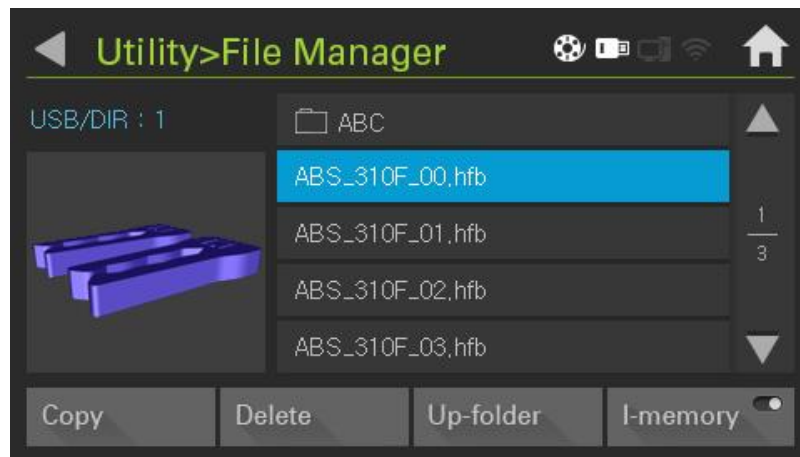

[1] Copy	Copies selected file after moving with $\Delta \nabla$
[2] Delete	Deletes selected file
[3] Up-Folder	Gets out from inside folder to top folder
[4] USB/inside memory	Enters to USB / inside memory

• Main > Utilities > Motion

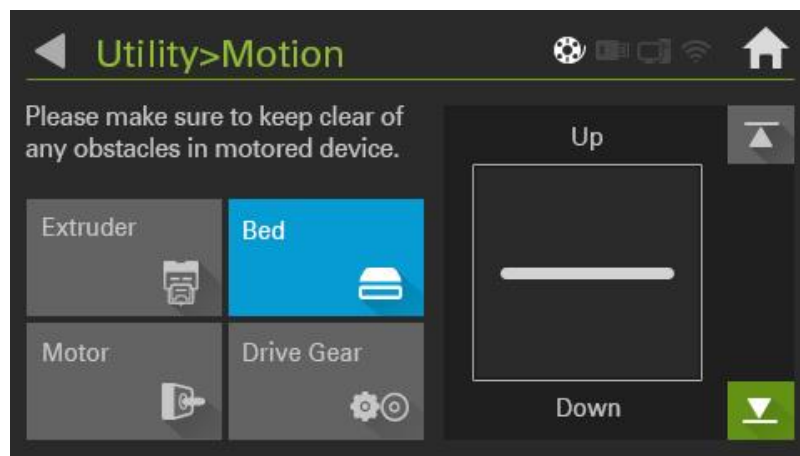

[1] Extruder	Moves the extruder to home and parking point
[2] Bed	Moves bed up and down
[3] Motor	Fixes or manually moves extruder
[4] D-Gear	Rotates extruder gear

• Main > Utilities > Diagnostic

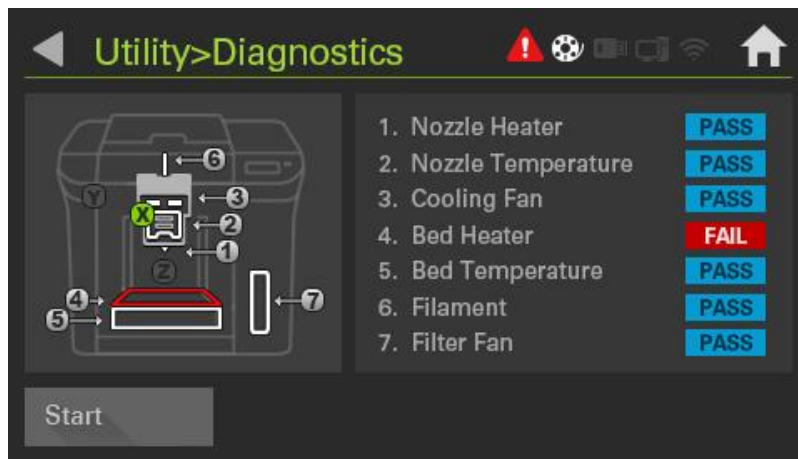

[1] Start	Self-diagnoses main parts (enters to above screen, once 'Warning' icon is pressed)
-----------	--

• Main > Utilities > LED & Sound



[1] Normal Color	Selects inside light color in the time of not printing
[2] Printing Color	Selects inside light color in the time of printing
[3] Sound	Conducts setting up and down of button touch volume

• Main > Utilities > Auto Level Test

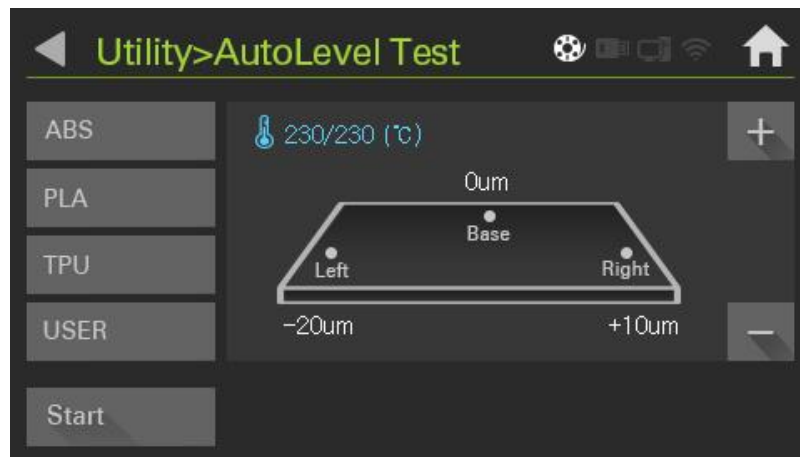

[1] Start | Selects filament suitable material and starts test

• Main > Utilities > System Log

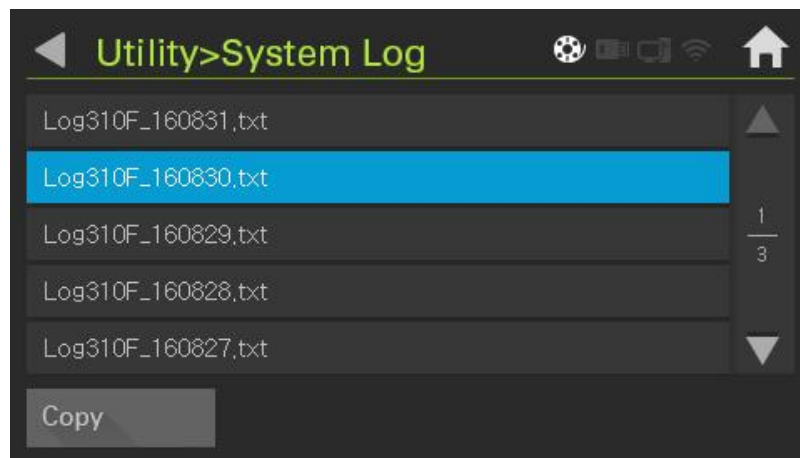

[1] Copy | Copies system log

• Main > Setting

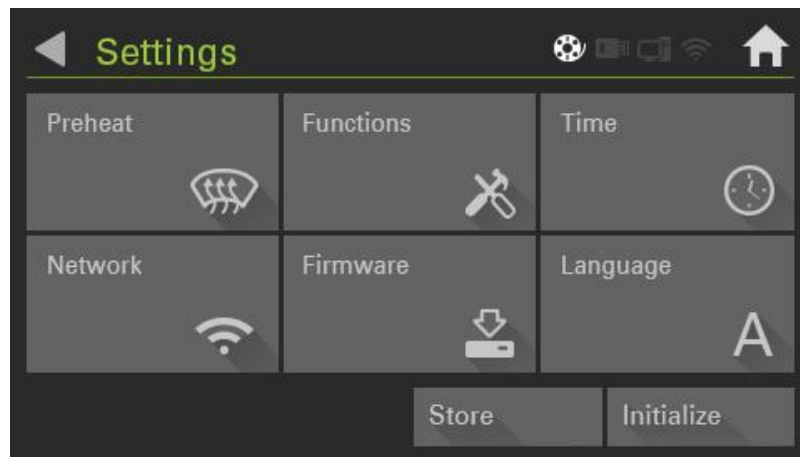

[1] Preheat	Adjusts setting value of filament temperature
[2] Function	Configures filament detection sensor and filter ON/OFF
[3] Time	Configures current time
[4] Network	Transmits Gcode using inside WIFI
[5] Firmware	Updates firmware
[6] Language	Selects language
[7] Store	Saves current setting
[8] Initialize	Initializes current setting

• Main > Setting > Preheat

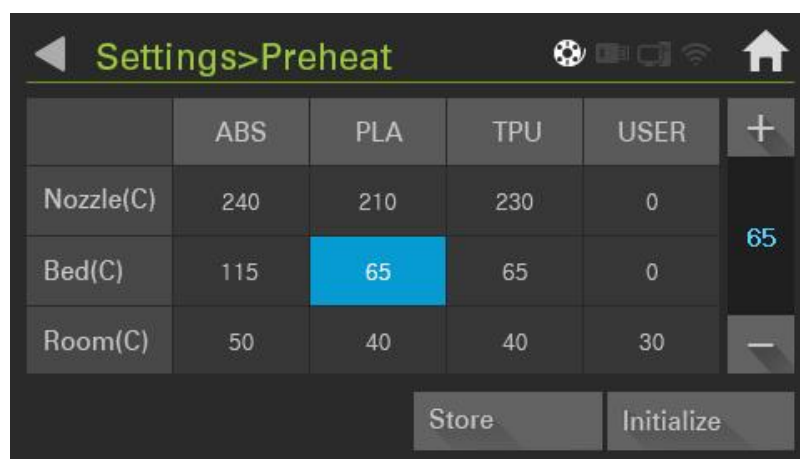

User can configure selected temperature with + - button

• Main > Setting > Function

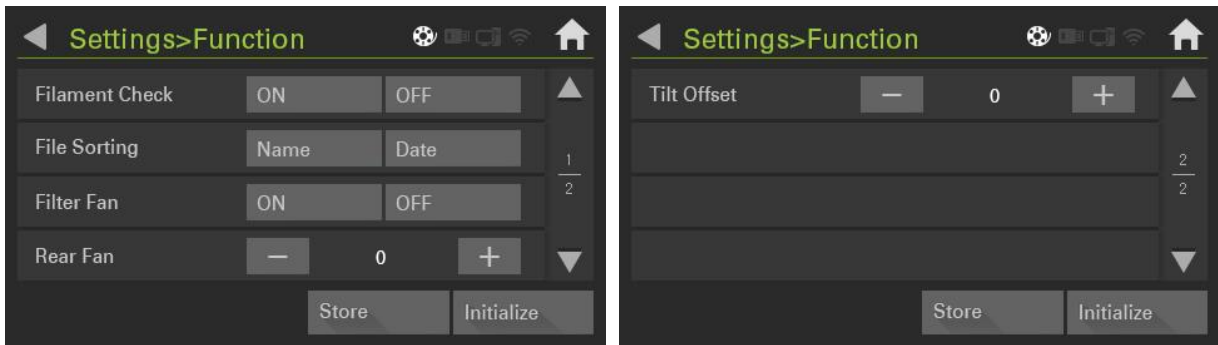

[1] Filament Check	Turns ON/OFF the filament detection sensor
[2] File Sorting	Sorts file order by name/date
[3] Filter Fan	Turns ON/OFF filter fan
[4] Rear Fan	Adjusts rear fan power with + - button. Flexible adjustment is required based on outside environment temperature
[5] Tilt Offset	Configures nozzle and bed interval. Narrows nozzle and bed interval with '-' button

• Main > Setting > Time



Configures time

• Main > Setting > Network

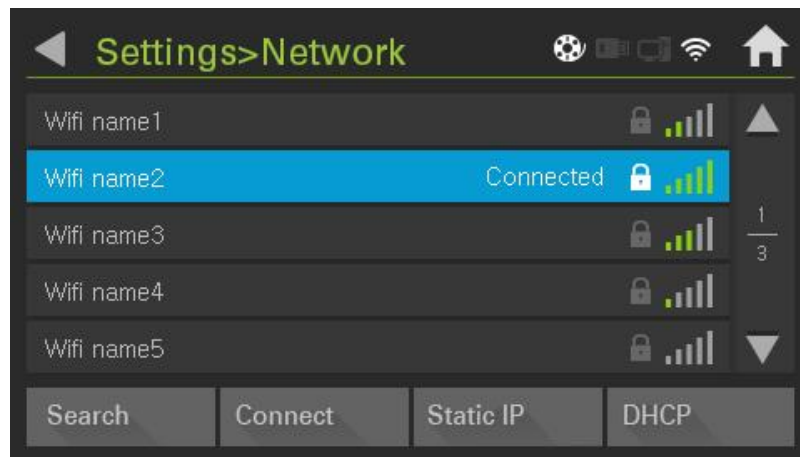

[1] Search	Searches Wi-Fi signal
[2] Connect	Connects to selected Wi-Fi
[3] Static IP	Selects fixed IP
[4] DHCP	Selects flexible IP

• Main > Setting > Firmware

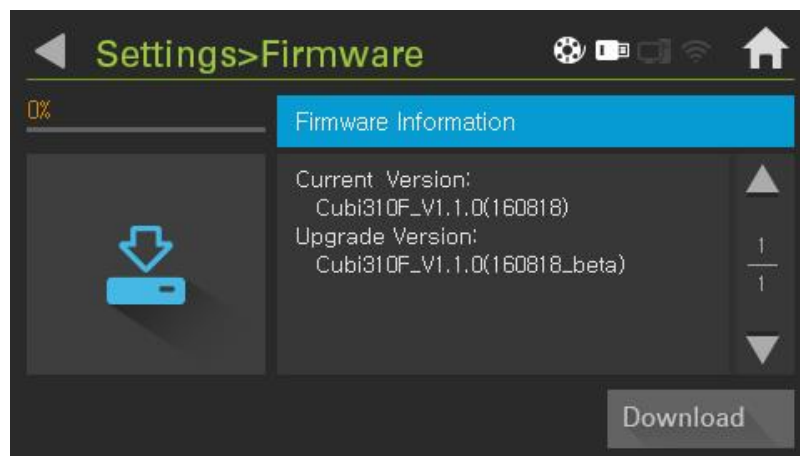

[1] Download	Installs new firmware version using USB memory. (Refer to 11-7. Firmware update section)
--------------	--

• Main > Setting > Language

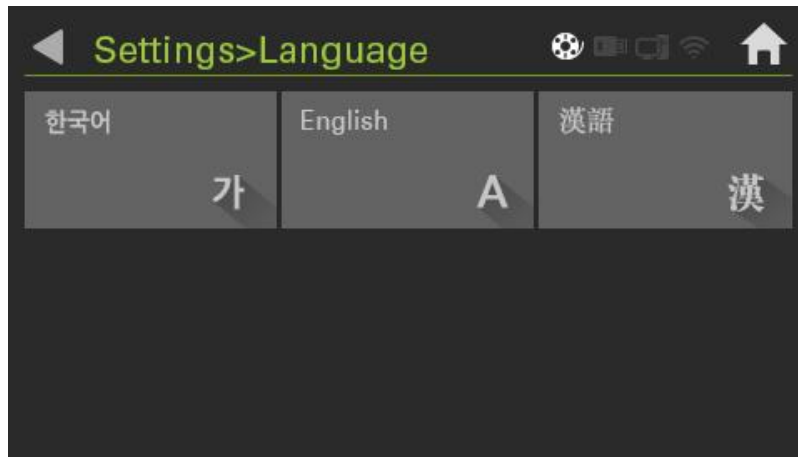

Basic language is English. Other languages can be selected

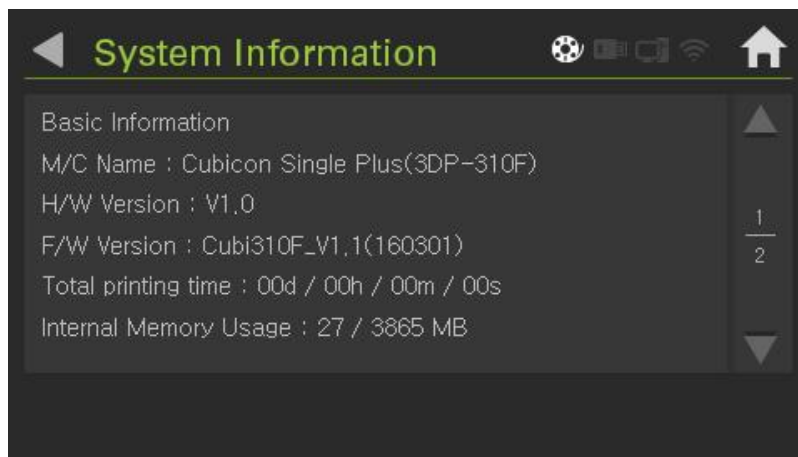

• Information



Indicates the printer information and total printing time, inside memory capacity and network information

11. Printer maintenance and repair

11-1. Extruder detaching

	<p>* Printer malfunction may occur, in the case of separating or installing removable extruder while power is ON. Make sure to proceed the detachable extruder separation/installation when the printer power is OFF and nozzle temperature is equal to indoor temperature.</p> <p>* Make sure to wear gloves and mind possible scalding due to hot extruder in the time of separating the detachable extruder in hot temperature.</p>
	<p>* be careful of the sensor or other equipment malfunction in the case of separating the detachable extruder while the filament is put into extruder.</p> <p>* In the case of abnormal unloading due to malfunction, cut out the filament from filament entry of the extruder and separate the extruder mindfully by pressing filament handle.</p>

(1) Detaching

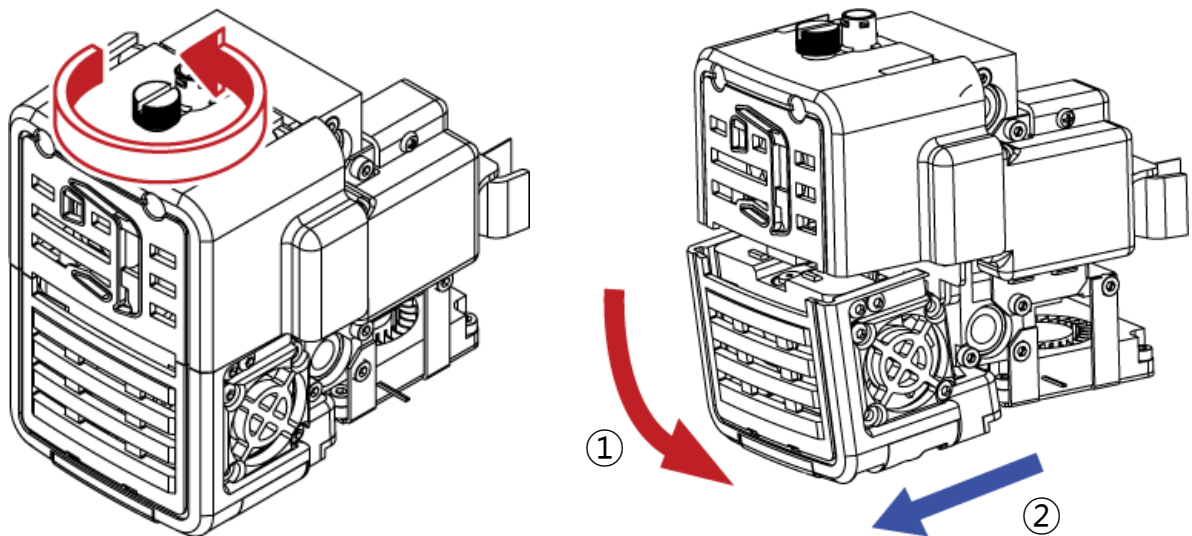

Turn off the printer power and untie knob of the extruder in counter clockwise direction.

Please hold the extruder with one hand while untying the knob, because the extruder may fall into bed in the time of completely untying.

The extruder will be separated, once detachable extruder is pulled down.

Mind that extruder might be tight as it is basically inserted to fixed part fan.

(2) Attaching

Attaching is basically in **reverse order of detaching**.

Make sure to attach the extruder after inserting it to fixture part and tighten knob in clockwise direction, once you can hear **clicker** after hole, which is put on shaped fan of rear extruder, is engaged. Do not put the knob with force as accurate combination is required. Instead, proceed attaching process again.

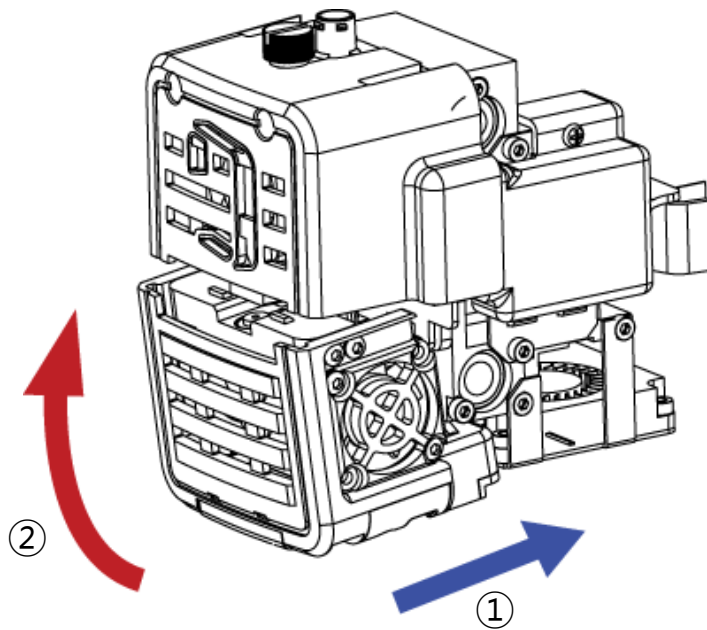

- * Make sure to turn off the printer power to separate/install the detachable extruder, proceed the work after temperature of extruder nozzle is completely cooled off.
- * Mind possible scalding if the removable extuder separation/installation is unavoidable in high nozzle temperature condition.
- * Make sure not to install / separate detachable extruder with extreme force as it may cause the extruder part damage.
- * Printing in the case of detachable extruder is not properly installed to fixture part or removable setscrew is not tightened condition, may cause problem of the extruder installation or malfunction which make printing impossible. Make sure to install the extruder properly in prior to using the printer.
- * Make sure not to touch the extruder part or cause shock with wet hand as the extruder includes electric equipment.

11-2. Extruder maintenance

Nozzle of the extruder is located at the bottom of the extruder and it is the part, which makes model as filament melts and comes out.

Nozzle is the consumable part of the printer and can be worn out or filament carbonization leftover, impurities of filament might be piled up inside due to continuous nozzle use. Therefore regular nozzle replacement is required. However, in the case of improper nozzle control, several problems related to the nozzle can occur earlier than normal nozzle use period and it may cause poor printing quality. In the case of serious printing quality problem occurrence, the nozzle cover might be blocked and it requires the nozzle replacement.

Regular nozzle cleaning is required for the nozzle continuous use with uniform printing quality.

(1) Cleaning gear contaminants

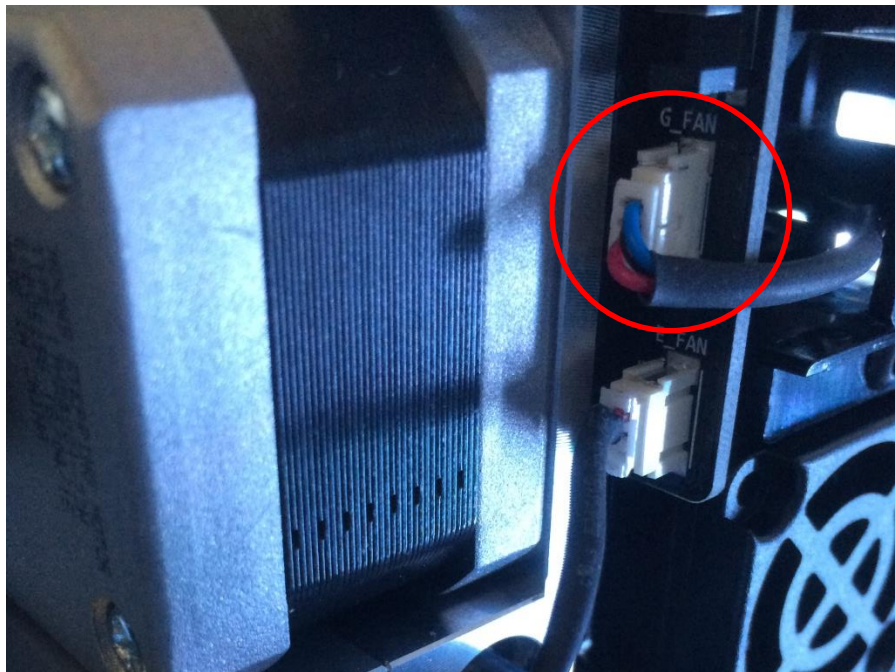

Turn off the printer power and pull out G_FAN from the extruder rear side. **Be mindful that damage might occur in the cable pull out process.**

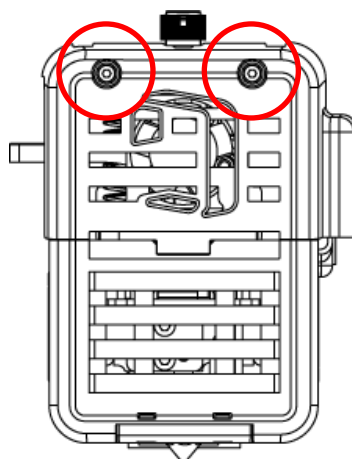

Turn and separate the bolt from cover front in counterclockwise direction with wrench of 2Ø diameter.

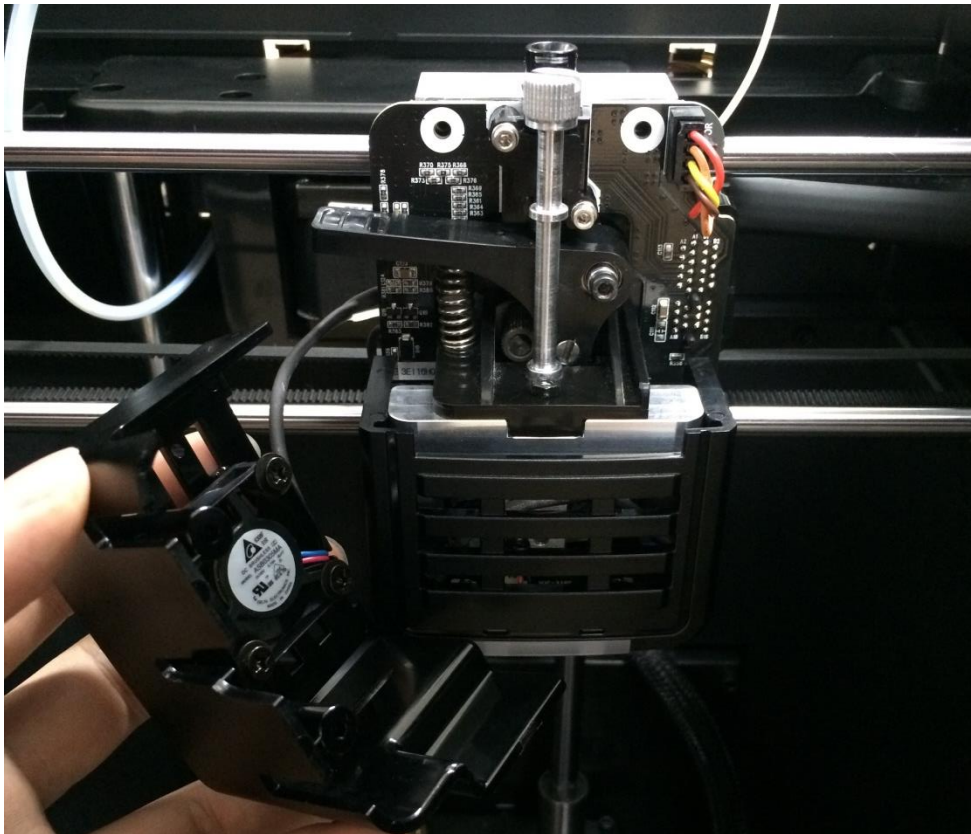

Be mindful of a gear fan, which is installed to the cover and separate the cover. Then remove all filament leftover and filament powder from the gear with the antistatic brush.



Press the handle and clean dusts with antistatic brush.



The extruder gear can be rotated with D-gear of motion by turning the power ON in the extruder pullout condition. Make sure to rotate the gear pressing handle. In the case of cleaning with air compressor, quality decrease and equipment malfunction may occur due to powder insert to shaft.



- * Make sure to rotate the gear by pressing handle in the process of the gear cleaning. The gear abrasion may occur in the case of moving the gear without pressing handle.
- * Be mindful that equipment malfunction might be caused due to powder insert to the shaft in the air cleaning process.
- * Do not put conductive materials into cleaning part during the printer power is ON. It may cause equipment shock.

(2) Cleaning of filament channel contaminants

Basically, the extruder, which uses all provided material or mixes all materials are not recommended. Filaments have different property and temperature. Those differences may be accumulated slowly and they may cause serious problems. Even though the inside filament can be deleted in the time of using ABS during PLA use period, PLA ingredient may remain on a wall surface. Those filament leftovers are accumulated continuously and sometime they cause printing failure due to nozzle blockage (Below picture shows the phenomenon, which is caused by the filament mix.)



Make sure to remove the filament with tweezers, which is inserted to filament entrance of detachable extruder

(3) Inside nozzle cleaning

Cleaning inside nozzle is basically possible with filament loading. Clean the inside with nozzle control pin in the case of loading is impossible due to change of inside filament property caused by materials mix. Make sure not to push in forcefully as it may cause damage to inside.

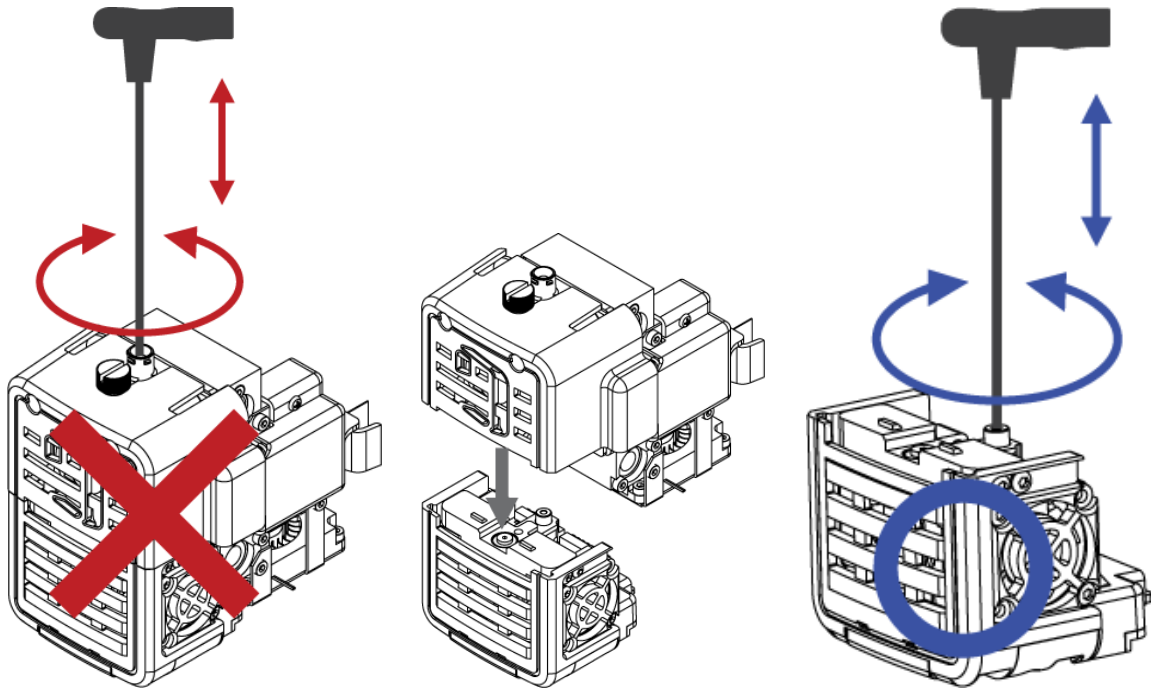

- * Make sure to wear gloves as inside nozzle cleaning is proceeded in hot condition and be mindful of possible scalding
- * Make sure to work holding only plastic part of detachable extruder in hot condition. Metal part and rubber part are in hot condition.
- * Nozzle control pin is not required to be used often if it does not mix material.

11-3. Auto leveling interface part maintenance

The extruder nozzle end part of Cubicon single plus touches interface part of heating bed and decides electric current applying necessity. Also, it recognizes the interval between heating bed and nozzle and adjusts bed height automatically. Therefore in the case of contaminants presence on heating bed interface part and nozzle end part, auto leveling will be failed due to poor electric current application. Make sure to clean contaminants for normal auto leveling operation.

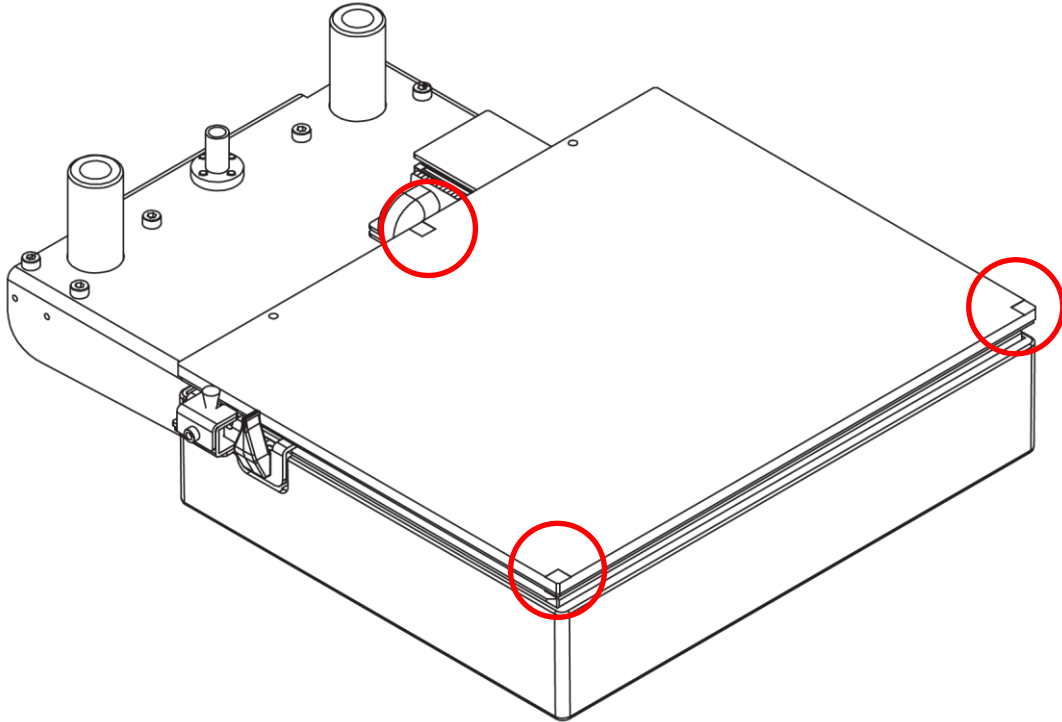

3 points, which are indicated in red, in above picture, are used for auto leveling interface. The filament melts and puffs and it causes pollution in the process of auto leveling of heating bed auto leveling interface. Auto leveling failure occurs due to melted filament fixation in the case of not removing and neglecting pollution. Make sure to clean the interface part with tweezers or scraper in prior to printing.

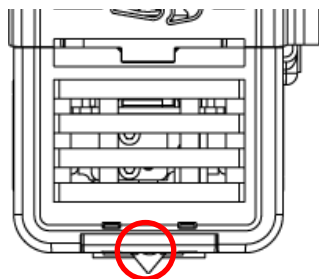

Above nozzle in the extruder picture is directly contacted part in auto leveling process. It basically proceeds cleaning it printing process, but it gets carbonized easily due to filament staining in printing process. Make sure to clean with a wire brush, which is equipped to an antistatic brush.

11-4. Heating bed maintenance



The heating bed is a floor, on which printing material is formed by melting and extruding filament. The heating bed gets polluted easily by filament or filament pieces, which is melted and attached in the formation process. In the case of continuous printing in polluted condition, contaminants sticks at formation too, and it causes pollution of formation or poor formation attachment to the heating bed in the printing process.

Make sure to maintain the heating bed in tidy place before and after printing to prevent poor printing quality due to printing material pollution.

① Remove filament leftover of the heating bed, using tools such as tweezers, scraper or a brush. Be mindful of heating bed surface damage in a tool use process. Lamination gets peeled off due to surface damage and it causes poor printing material sticking.

② Filament leftover or filament sign on the surface of heating bed in formation process may not be removed easily. Make sure to remove those serious pollutions wiping as if melting with right amount of high purity acetone.

* Make sure to use only high purity acetone for the heating bed cleaning

	<ul style="list-style-type: none"> * Some stain may be seen on the heating bed surface. You do not need to concern on this matter as those stains usually occur in lamination process and do not effect to the heating bed property. * The heating bed lamination usage period depends on user's printing habit. * The heating bed of Cubicon single plus can process printing without using kapton tapes in appropriate temperature in the case of printing our company's ABS/PLA. However users can purchase and use kapton tape depending on their printing habit or printing model.
	<p>In the case of melted filament printing method, contraction may occur if melted filament is hardened and it may lead to printing floor bird-caging. Contradiction can be improved depending on printing temperature condition or heating bed adhesive strength or slicing option change. Most of contradiction phenomenon occurs often and contradiction difference occurs based on contradiction degree. Make sure to consider a design method, which can disperse contradiction force in 3D model designing process.</p>
	<ul style="list-style-type: none"> * Do not use solvents other than acetone for the heating bed as they lead to lamination damage. * Make sure that acetone shall not stain onto other objects in the time of using acetone for heating bed cleaning as it may lead to the product damage. * Make sure to use acetone in well ventilated place and be midful of acetone maintenance. (Make sure to follow safety regulations, which is written on acetone package) * Do not use a wet tissue as abluent ingredient of some wet tissues may lead to heating bed lamination pollution. * Do not seprate or force the heating bed for formation pullout as it may lead to heating bed malfunction. * Auto leveling is adjusted with unlaminated bed part. Make sure to remove foreign substances in prior to printing.

11-5. Filter replacement

Purafil accelerator, HEPA filter, clear filter, which consist of triple structure of deodorizing filter is used for filtering out contaminants, which occurs from a printer of FFF type in Cubicon single plus.

Contaminants of the clean filter may cause not only poor filter performance but also filter fan operation interference and lead to the product malfunction.

Do not cleanse polluted clean filter. But replace it with new one.

Replacement period of the clean filter depends on the product use environment and user's printing habit.

Generally, it is recommended to replace the clean filter every six months.







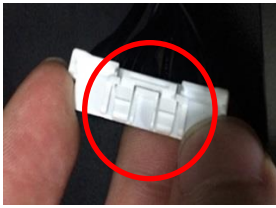
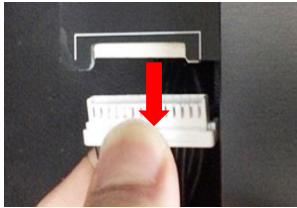

Make sure to install the clean filter to a case in appropriate direction. Inappropriate installation may lead to poor filter performance and a fan malfunction.

11-6. Rubber brush & wire brush replacement period and method

Heat resisting rubber cleaning brush and wire brush are attached to the left side of heating bed for cleaning the end part of nozzle. Make sure to remove filament leftover as it may cause secondary nozzle pollution. Those two brushes are consumable products. Therefore, user can replace those products through designated A/S center in the case of product damage.

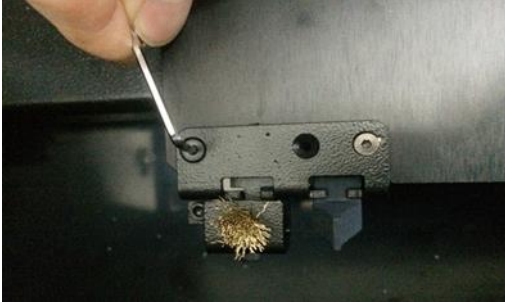
Replacement period of nozzle cleaning brush is when the brush cannot function properly due to filament leftover and the brush replacement is required in this case. Continuous brush use without replacement may lead to auto leveling failure and nozzle shock.

<p>① Press fixture to the bottom part of rear socket and pull out socket</p>	<p>Bottom part fixture</p>	<p>Pull out</p>
		
<p>② Take out the bed by pulling it up</p>	<p>③ Rotate and untie the bed in 2Ø wrench counterclockwise direction.</p>	

	
④ Untie in 2.5Ø wrench counterclockwise direction.	⑤ Replace a brush in complete separated condition.
	
	<ul style="list-style-type: none"> * Make sure that bed temperature is cooled off and its power is OFF in prior to proceed work. * Make sure to wear gloves in separation/installation process to prevent hand injury as the bed is fixed with extreme magnet force. * Assembly is the vice versa of separation.

11-7. Firmware update

User can download the firmware from Cubicon homepage and install new version of the firmware.

(1) Firmware installation by cubicreator

Setting –Install new version of the firmware after selecting updated firmware and a file to install. (Refer to the cubicreator manual for detailed information.)

(2) Firmware installation through USB memory

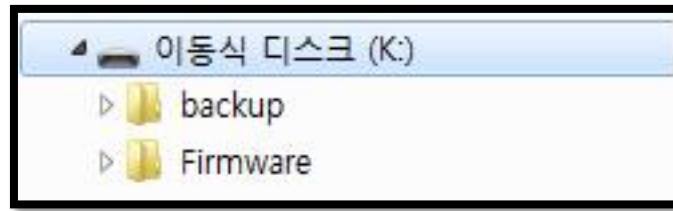

Create 'Firmware' folder in 'Root' folder of USB memory.

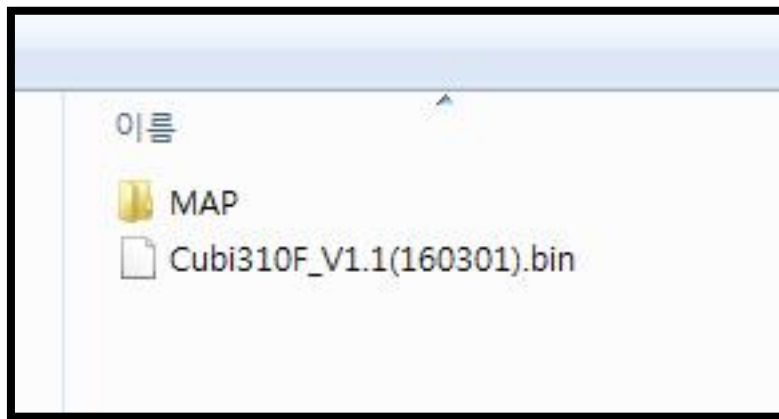

Copy UI file and new version of firmware into 'Firmware' folder.

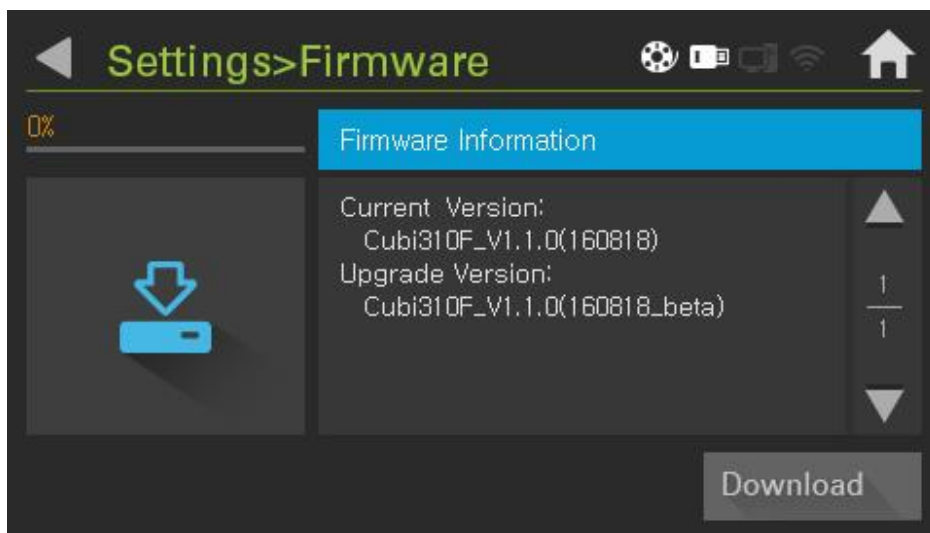

Select firmware icon of 'Setting' after inserting USB memory to Cubicon single plus. Firmware update starts, once 'Download' button is selected. Make sure to initialize after firmware update completion-rebooting. Initialize process takes no more than 1 minute.

11-8. Firmware recovery

Cubicon Single Plus has the function to recover previous firmware to prevent any possible problem in firmware update process.

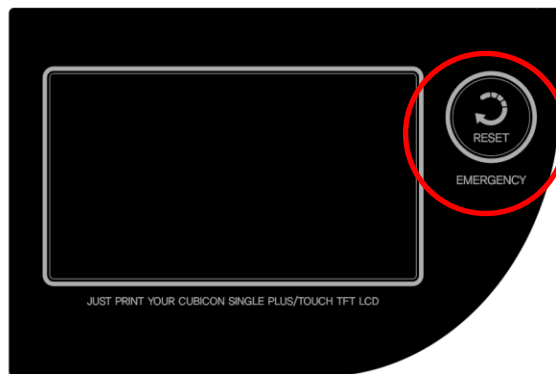

(1) Operation method

Keep pressing 'Reset' button after the printer power is OFF. Keep pressing 'Reset' button for 20 seconds after the printer power is ON to recover previous firmware recovery.



Touch LCD reset and rebooting means successful recovery completion.

12. Trouble shooting

	<p>* The printer hardware problem can be solved by initializing through {Setting > Function > Initialize} or through firmware update.</p> <p>* Printing quality can be different depending on printing condition or cubicreator option setting in G-Code process. Therefore make sure to check quality using different printing condition or option.</p>
	<p>It is important to inspect problem source clearly in the case of equipment problem occurrence. Make sure to film of modelling file (STL), hfb(hvs) file, related problem picture and video to provide for customer support.</p>

1) USB memory data is invisible.

- Cubicon Single Plus supports only formats in FAT32 form file system.
- Cubicon Single Plus supports only English named files. In the case of file names in different languages, letters may break or it may seem as empty blank. Therefore make sure to change file name from other language to English for proper use.
- Printing might be interrupted in the case of including characters such as “.” in file name. (System recognizes “.” from back as filename extension)
- Only *.hfb and .hvs files are visible on LCD screen of Cubicon Single Plus. Make sure to check if a file is copied properly into USB memory.
- Printer may recognize up to 255 USB memory files. Make sure to arrange files in proper quantity.

2) USB memory data cannot be printed.

- Make sure to check if selected files are in G-Code of *.hfb , *.hvs filename extension.
Only sliced G-Code (*.hfb , *.hvs filename extension) files can be used by cubicreator in Cubicon Single Plus. G-Codes, which use different slicing programs, cannot be printed and they may cause equipment damage.
- USB memory data might have been damaged. Try to remake and use remade G-code file.
- Printing cannot be processed in the case of improper implementation in memory copy process after slicing by using cubicreator. Make sure to use the cubicreator and check if related G-Code is proper to use. G-code is improper to use in the case of abnormal printing channel, which is shown as G-Code.
- Slicing might have been gone wrong through the cubicreator due to improper 3D model. Import original 3D model from the cubicreator and check if there is any problem in slicing or G-Code transmission normality. Use special 3D model inspection program and check any possible problem of 3D model.
- There might be a problem in USB memory data storage due to security program of PC or virus. Take appropriate measures for solving problem after inspection and try again.

3) Printing cannot be proceeded due to PC and USB cable connection.

- Check if there is any problem in PC and printer USB cable connection.
- Check if Cubicon Single Plus driver is installed to PC properly.
- . Check if PC problem is related to virus and reinstall driver after solving the problem.
- Connection problem may occur due to communication problem of PC and printer. Try to reconnect USB cable or rerun the cubicreator or turn OFF and ONN rear power button.

4) Printing cannot be proceeded due to PC and WIFI connection

- Check if PC and the printer are connected to identical router.
- Use the printer and PC in places, where WIFI is well connected.

- Connection interruption may occur depending on a wireless router model.
- Try to initialize the printer setting or turn OFF and ON the printer power.
- Refer to 22P for detailed information.

5) Filament cannot be extruded with the nozzle.

- Check if the filament is a genuine product. Some filaments have different temperature condition from other genuine filaments and problem may occur in extruding process due to those filaments' serious temperature change. Serious temperature change may lead to the extruder malfunction. **The printer malfunction due to non-genuine filament use is excluded from complimentary A/S.**
- Check if the filament supply is normal. Untie and rearrange the filament in the case of problems such as the filament twisting in a spool or untied filament. It is highly recommended to untie and rearrange filament as twisted or untied filament may cause continuous problem.
- The filament nature may change from its original nature due to pollution such as humidity or dust. Such filament use may cause malfunction such as extruder blockage. Use opened filament as soon as possible and keep the filament in fixed condition in the spool using plastic to prevent the filament from humidity/dust. Make sure to keep the filament only for short period.
- Check if supplied filament is not too thick or not too thin either. The filament in 1.6~1.9mm diameter shall be used for accurate filament supply in Cubicon Single Plus. Using too thin or thick filament may be inserted to equipment and it may lead to equipment malfunction.
- In the case of inside extruder filament gets twisted or caught in equipment, extruding cannot be processed due to extruding problem. Make sure to separate detachable extruder and remove problematic filament. Inside extruder twisting problem may easily occur in the case of filament of low printing temperature. Twisting problem can be solved by adjusting inside equipment temperature to low degree.
- Check if detachable extruder installation is proper. Error message may occur on LCD screen in the case of problem occurrence.
- **Check if filament in use and the printer extruder temperature are proper.**
- Replace damaged nozzle. The nozzle is consumable product and can be replaced through A/S.

6) A model is not attached to a floor (heating bed) and is detaching.

- Check if filament is genuine product. Some filaments are not glued to the manufacturer's heating bed and it may cause equipment malfunction in printing process.
- The filament nature may change from its original nature due to pollution such as humidity or dust. Those polluted filaments may be glued to the heating bed poorly. Use opened filament as soon as possible and keep the filament in fixed condition in the spool using plastic to prevent the filament from humidity/dust. Make sure to keep the filament only for short period.
- **Remove contaminants from heating bed. General wet tissues may cause damage to heating bed lamination. Never use wet tissues for heating bed.**
- Check if filament in use and heating bed, extruder temperature condition are proper. The heating bed use in Cubicon Single Plus can be glued well if only it can maintain proper temperature condition with filament in use. And the temperature condition can be different depending on printing environment.
- Check if the heating bed attachable area is not too small or formed floor is not irregular. Use a floor supportive material option in the G-Code formation process or slow down the first layer printing speed to solve the problem.
- **Use proper tape if required. Applying special heat resisting tape such as kapton tape to heating bed in accordance with formed model or filament type, might be helpful for a model attachment. Corner**

contact point which is auto level shall be attached with exposure. Make sure to calibrate tilt offset as thick as tape thickness.

- Check if the heating bed lamination has not been damaged or the heating bed bending is not serious. Replace heating bed in the case of heating bed lamination damage or serious heating bed bending. The heating bed is consumable material and can be replaced through A/S.

7) A part of the model, mostly floor border detach from the floor.

- Refer to “6) A model is not attached to a floor (heating bed) and detaching” and take appropriate measure.
- The problem can be solved partially with option such as inside fill density in G-Code formation process.
- Material contraction from heat melting printer is the main reason. Adjust printing condition (extruder, heating bed, printer inside temperature) or use less contracted materials. Contraction can be improved somewhat depending on material. However model modification is the most effective method for contraction improvement, which appears by filament solidification as natural phenomenon.

8) The middle of model is cracked.

- This is caused by contraction of the material caused by printer using the thermal melting method. Adjust printing condition (extruder, heating bed, printer inside temperature) or use less contracted materials. Contraction can be improved somewhat depending on material. However model modification is the most effective method for contraction improvement, which appears by filament solidification as natural phenomenon.
- The problem can be solved partially with option such as inside fill density in G-Code formation process

9) The model does not detach from a floor (heating bed)

- Wait until heating bed cools off sufficiently. Forceful pull out may harm the heating bed. The model is attached onto the floor in the heating bed printing process of Cubicon Single Plus. The model can be detached easily, once the heating bed cools off after printing completion. Proper temperature for the model detaching is different based on the filament and model model and environment.
- In the case of heating bed cannot be detached after heating bed cooled off (cold temperature), try to pull out the model by pushing its floor part with flat ended object.
- In the case of continuous model leftover fixture to the heating bed, the model cannot be detached from bed as it is attached to fixated leftover. Make sure maintain the heating bed surface tidy.
- Replace the heating bed in the case of heating bed lamination damage through A/S.

10) The model is printed partially or it is not printed at all or it is printed abnormally.

- Refer to “5) Filament cannot be extruded with nozzle.” and take appropriate measure.
- Check printing model and G-Code. Problem may occur in G-Code formation process in the case of abnormal model. Modify model and try again.
- Problem may occur in printing due to printed model and stanchion interruption based on model or stanchion in use. The problem can be solved in the case of slicing method change (slicing option adjustment or direction change).
- Remove contaminants from inside nozzle.
- In the case of continuous problem occurrence although proper model, the nozzle shall be replaced by A/S.

11) Printing cannot be processed due to auto leveling failure.

- Check if environmental vibration affects equipment in auto level process. Auto level may fail in the case of vibration transmission to equipment.
- The printer proceeds auto level of bed in prior to print. The printer stops printing in the case of auto leveling failure (automatically proceeding for several times) due to some reason.
- Make sure to maintain auto level contact point continuously.
- In the case of continuous problem occurrence, replace extruder cleaning brush or heating bed by A/S.
- **Auto leveling may fail depending on temperature and filament difference in non-genuine filament use.**

12) The presence detection sensor of filament is not operated properly.

- Make sure to check supplying filament's diameter is 1.6~1.9mm in prior to use it.
- **Flexible filament such as TPU may malfunction due to filament pressure to supply detection sensor. Make sure not to use filament supply detection function in this case.**
(Setting > Function > Filament Check "Off")
- The filament detection sensor may get worn out due to continuous use as it is consumable material. Replace the presence detection sensor through A/S.

13) Operation stops in printing process.

- Check power supply.
- In the case of continuous problem occurrence take a photo or video of problematic part and use A/S.

13. Product specification

Standard	
Product size	554x579x524 mm
Product weight	~25kg (~55lbs)
Packing box	640x630x610 mm (25.1x24.8x24.0 in)
Packing weight (including the product body and secondary accessories)	~32kg (70.1lbs)
Temperature	
Operation temperature	15 - 35 °C
Storage temperature	0 - 35 °C
Electricity	
AC input	Free Volt 100-240V~, 50/60Hz, 5A
Power Supply	24V DC @ 25A
Power consumption	~500W (MAX)
Memory and communication environment	USB Memory(FAT32), USB Cable, WIFI
Software	
Slicing software	Cubicreator v3.0 (for Windows)
Inputted 3D design file type	.stl , .obj
Operation system	Over Windows 7
Printing	
Printing technology	FFF (Fused Filament Fabrication)
Formation size	240x190x200mm (9.4x7.4x7.7 in)
Formation speed	Max 500mm/sec
Layer height setting	150~300um, Min 100um
Formation wall thickness	Optimal 400um+
Filament diameter	1.75mm
Filament type	ABS, PLA, Flexible Filament
Nozzle diameter	0.4mm
XY location precision degree	6.25um
Z location precision degree	1.25um
Nozzle maximum temperature	260°C
Heating bed maximum temperature	120°C

- The specifications can be changed, without advance notice, when needed to improve the product.